



**HAL**  
open science

## **GENESIS: co-location of geodetic techniques in space**

Pacôme Delva, Zuheir Altamimi, Blazquez Alejandro, Mathis Blossfeld, Johannes Böhm, Pascal Bonnefond, Jean-Paul Boy, Sean Bruinsma, Grzegorz Bury, Miltiadis Chatzinikos, et al.

► **To cite this version:**

Pacôme Delva, Zuheir Altamimi, Blazquez Alejandro, Mathis Blossfeld, Johannes Böhm, et al.. GENESIS: co-location of geodetic techniques in space. *Earth Planets and Space*, 2023, 75 (1), pp.5. 10.1186/s40623-022-01752-w . obspm-03938404

**HAL Id: obspm-03938404**

**<https://hal-obspm.ccsd.cnrs.fr/obspm-03938404>**

Submitted on 29 Mar 2023

**HAL** is a multi-disciplinary open access archive for the deposit and dissemination of scientific research documents, whether they are published or not. The documents may come from teaching and research institutions in France or abroad, or from public or private research centers.

L'archive ouverte pluridisciplinaire **HAL**, est destinée au dépôt et à la diffusion de documents scientifiques de niveau recherche, publiés ou non, émanant des établissements d'enseignement et de recherche français ou étrangers, des laboratoires publics ou privés.







Distributed under a Creative Commons Attribution 4.0 International License

FULL PAPER

Open Access



# GENESIS: co-location of geodetic techniques in space

Pacôme Delva<sup>1\*</sup> , Zuheir Altamimi<sup>2</sup>, Alejandro Blazquez<sup>3,4</sup>, Mathis Blossfeld<sup>5</sup>, Johannes Böhm<sup>6</sup>, Pascal Bonnefond<sup>1</sup>, Jean-Paul Boy<sup>7</sup>, Sean Bruinsma<sup>4,8</sup>, Grzegorz Bury<sup>9</sup>, Miltiadis Chatzinikos<sup>1</sup>, Alexandre Couhert<sup>4,8</sup>, Clément Courde<sup>10</sup>, Rolf Dach<sup>11</sup>, Véronique Dehant<sup>12</sup> , Simone Dell'Agnello<sup>13</sup>, Gunnar Elgered<sup>14</sup>, Werner Enderle<sup>15</sup>, Pierre Exertier<sup>8</sup>, Susanne Glaser<sup>16</sup>, Rüdiger Haas<sup>14</sup>, Wen Huang<sup>16</sup>, Urs Hugentobler<sup>17</sup>, Adrian Jäggi<sup>11</sup>, Ozgur Karatekin<sup>12</sup>, Frank G. Lemoine<sup>18</sup>, Christophe Le Poncin-Lafitte<sup>1</sup> , Susanne Lunz<sup>16</sup>, Benjamin Männel<sup>16</sup> , Flavien Mercier<sup>4,8</sup>, Laurent Métivier<sup>2</sup>, Benoît Meysignac<sup>3,4</sup>, Jürgen Müller<sup>19</sup>, Axel Nothnagel<sup>6</sup>, Felix Perosanz<sup>4,8</sup>, Roelof Rietbroek<sup>20</sup>, Markus Rothacher<sup>21</sup>, Harald Schuh<sup>16</sup>, Hakan Sert<sup>12</sup>, Krzysztof Sosnica<sup>9</sup>, Paride Testani<sup>22</sup>, Javier Ventura-Traveset<sup>23</sup>, Gilles Wautelet<sup>24</sup> and Radoslaw Zajdel<sup>9</sup>

## Abstract

Improving and homogenizing time and space reference systems on Earth and, more specifically, realizing the Terrestrial Reference Frame (TRF) with an accuracy of 1 mm and a long-term stability of 0.1 mm/year are relevant for many scientific and societal endeavors. The knowledge of the TRF is fundamental for Earth and navigation sciences. For instance, quantifying sea level change strongly depends on an accurate determination of the geocenter motion but also of the positions of continental and island reference stations, such as those located at tide gauges, as well as the ground stations of tracking networks. Also, numerous applications in geophysics require absolute millimeter precision from the reference frame, as for example monitoring tectonic motion or crustal deformation, contributing to a better understanding of natural hazards. The TRF accuracy to be achieved represents the consensus of various authorities, including the International Association of Geodesy (IAG), which has enunciated geodesy requirements for Earth sciences. Moreover, the United Nations Resolution 69/266 states that the full societal benefits in developing satellite missions for positioning and Remote Sensing of the Earth are realized only if they are referenced to a common global geodetic reference frame at the national, regional and global levels. Today we are still far from these ambitious accuracy and stability goals for the realization of the TRF. However, a combination and co-location of all four space geodetic techniques on one satellite platform can significantly contribute to achieving these goals. This is the purpose of the GENESIS mission, a component of the FutureNAV program of the European Space Agency. The GENESIS platform will be a dynamic space geodetic observatory carrying all the geodetic instruments referenced to one another through carefully calibrated space ties. The co-location of the techniques in space will solve the inconsistencies and biases between the different geodetic techniques in order to reach the TRF accuracy and stability goals endorsed by the various international authorities and the scientific community. The purpose of this paper is to review the state-of-the-art and explain the benefits of the GENESIS mission in Earth sciences, navigation sciences and metrology. This paper has been written and supported by a large community of scientists from many countries and working

\*Correspondence:

Pacôme Delva

pacome.delva@obspm.fr

Full list of author information is available at the end of the article



© The Author(s) 2023. **Open Access** This article is licensed under a Creative Commons Attribution 4.0 International License, which permits use, sharing, adaptation, distribution and reproduction in any medium or format, as long as you give appropriate credit to the original author(s) and the source, provide a link to the Creative Commons licence, and indicate if changes were made. The images or other third party material in this article are included in the article's Creative Commons licence, unless indicated otherwise in a credit line to the material. If material is not included in the article's Creative Commons licence and your intended use is not permitted by statutory regulation or exceeds the permitted use, you will need to obtain permission directly from the copyright holder. To view a copy of this licence, visit <http://creativecommons.org/licenses/by/4.0/>.

in several different fields of science, ranging from geophysics and geodesy to time and frequency metrology, navigation and positioning. As it is explained throughout this paper, there is a very high scientific consensus that the GENESIS mission would deliver exemplary science and societal benefits across a multidisciplinary range of Navigation and Earth sciences applications, constituting a global infrastructure that is internationally agreed to be strongly desirable.

**Keywords** GENESIS satellite, Reference systems, Geodesy, Geophysics, Navigation, Positioning, Metrology, Space geodetic techniques

### Graphical Abstract

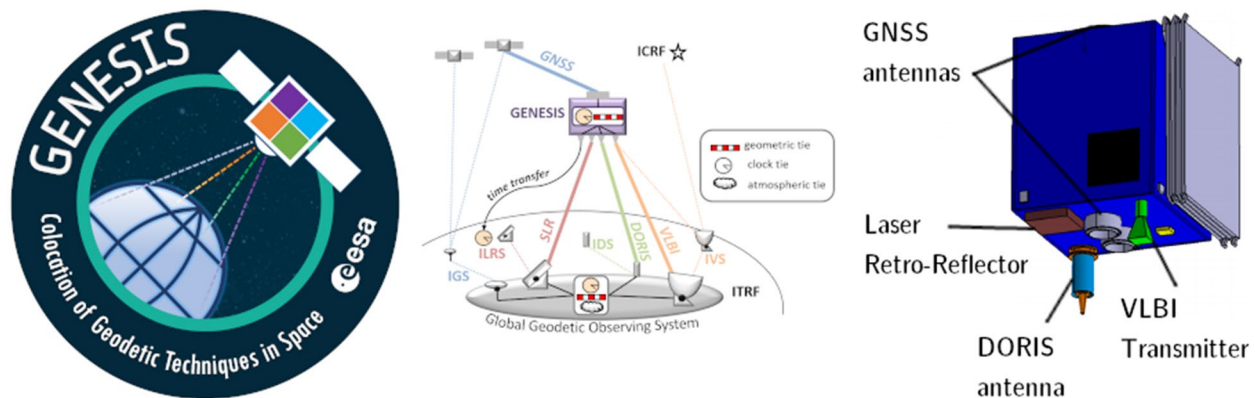

### Introduction

The GENESIS proposal is dedicated to improving and homogenizing time and space references on Earth and, more specifically, to realizing the Terrestrial Reference System (TRS) with an accuracy of 1 mm and a long-term stability of 0.1 mm/year. These numbers are relevant for many scientific and societal endeavors for which a precise realization of the TRS and the knowledge of the Earth's kinematic parameters are crucial.

Knowledge of Celestial Reference Frame (CRF) and of Terrestrial Reference Frame (TRF) is fundamental for orbit computation, in particular for metrological applications such as altimetry (e.g., ocean radar altimetry, laser and radar altimetry over land surfaces and ice sheets, and interferometric synthetic-aperture radar mapping of land surface change), as well as for more precise position determinations of Earth orbiting satellites. For instance, quantifying sea level change or the effects of ice melting using altimetry strongly depends on an accurate determination of the position of continental and island reference stations, such as those located at tide gauges, as well as the ground stations of tracking networks. Also, numerous applications in geophysics require absolute millimeter precision from the reference frame, as for example in the case of monitoring tectonic motion or crustal deformation for predicting natural hazards and inferring climate driven mass changes (non-tidal ocean, ice, atmospheric,

and hydrological) from observations of vertical and horizontal displacements of the Earth's surface.

A stable and accurate reference frame is needed for robust policy making in light of climate change. The quality of many operational monitoring systems are tied to the accuracy of the underlying reference systems. Reliable evidence-based policies, which make use of such operational data, and are expected to become more important in adaptation measures, are therefore directly dependent on the quality of international reference frames. The TRF accuracy and stability to be achieved, respectively 1 mm and 0.1 mm/year, represent the consensus of various authorities, including the International Association of Geodesy (IAG), which has enunciated geodesy requirements for Earth science through the Global Geodetic Observing System (GGOS) initiative (see Plag and Pearlman 2009). Hereafter, we will refer to these numbers as the GGOS accuracy and stability goals.

The General Assembly of the United Nations (UN) adopted a resolution on 26 February 2015: "A global geodetic reference frame for sustainable development" (United Nations General Assembly 2015). In this resolution the UN recognize the importance of "the investments of Member States in developing satellite missions for positioning and Remote Sensing of the Earth, supporting a range of scientific endeavors that improve our understanding of the Earth system and underpin decision-making,

and [...] that the full societal benefits of these investments are realized only if they are referenced to a common global geodetic reference frame at the national, regional and global levels”. Moreover, in this resolution, the UN “invites Member States to engage in multilateral cooperation that addresses infrastructure gaps and duplications towards the development of a more sustainable global geodetic reference frame”. In this article, we will explain that the GENESIS mission is precisely addressing the geodetic ground infrastructure gaps. The United Nations Committee of Experts on Global Geospatial Information Management (UN-GGIM) established a working group to develop a global geodetic road map that addresses key elements relating to the development and sustainability of the Global Geodetic Reference Frame (GGRF).

Several space missions in order to reach the GGOS accuracy and stability goals were proposed in the past, such as GRASP (Bar-Sever et al. 2009), E-GRIP (Jetzer et al. 2017) and E-GRASP/Eratosthenes (Biancale et al. 2017). Today, the GENESIS mission is timely considering the large number of long-term scientific undertakings, where many different space data need to be analyzed together, as, for example, for the quantification of the mass-loss in the polar regions, where altimetry missions (ICESat-2, CryoSat-2, Sentinel-6) and gravity field missions (GRACE and GRACE-FO) need to be jointly exploited. The strong statements by international bodies underline that the GENESIS

mission is highly needed and timely, being the only mission to cover this topic, worldwide.

A very large and strong scientific community involved in the worldwide networks and data and analysis centers of the four geometrical IAG Services supports the GENESIS mission, a component of the FutureNAV program of the European Space Agency (ESA). Clearly, GENESIS will deliver exploratory results across many Earth’s science disciplines, mainly where precise positioning, surface motions and mass movement are critical. The mission is thus supported by an active and broad community, and the downstream science and policy-making users will continuously benefit from the improvements in the TRF and of its link to the CRF.

**Summary of GENESIS science and mission objectives**

The GGOS was initiated by the IAG with the goal of providing a consistent high-quality TRF, crucial for the present day and future science application needs (Plag and Pearlman 2009; National Academies of Sciences, Engineering, and Medicine 2018, 2020). There exists a very wide spectrum of applications in Navigation and Earth sciences and far beyond that require a more accurate TRF, as illustrated in Fig. 1. The TRF is the indispensable fundamental metrological basis to allow a long-term consistent monitoring of the Earth’s system changes.

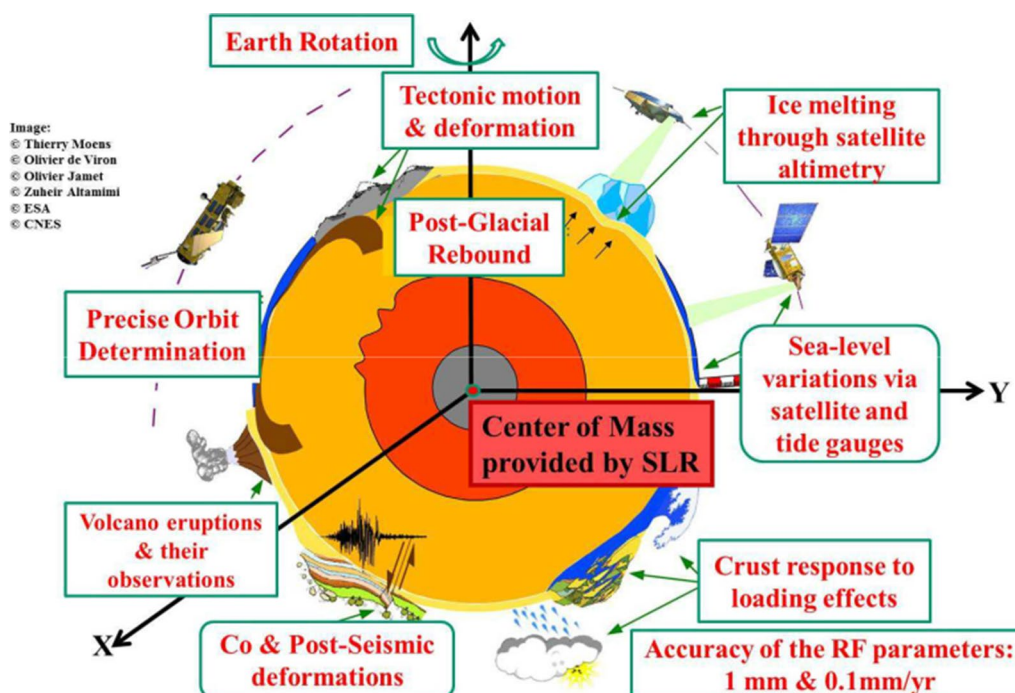

**Fig. 1** The GENESIS mission’s primary goal is a significant improvement of the International Terrestrial Reference Frame (ITRF). The ITRF is recognized to be the metrological foundation for all space- and ground-based observations in Earth Science and Navigation, and therefore this mission will potentially have a major impact in a large number of GNSS and Earth Observation applications

The GGOS accuracy and stability goals are required to detect the smallest variations in the Earth system components. These requirements are especially driven by the fact that the stability in the present TRF of about 0.5 mm/year is the most important contribution to the uncertainty in global sea level rise (see section [Altimetry and sea level rise](#)) and in many other geophysical processes. The primary goal of the GENESIS mission is, therefore, the establishment of a TRF supporting the GGOS accuracy and stability goals through the co-location of space geodetic techniques on a single satellite.

Nowadays, the TRF is realized by station coordinates and velocities for a globally distributed set of ground stations using a combination of the four major space geodetic techniques:

- Global Navigation Satellite System (GNSS);
- Doppler Orbitography and Radiopositioning Integrated by Satellite (DORIS), a radio satellite tracking system;
- the Satellite Laser Ranging (SLR) technique;
- and the Very Long Baseline Interferometry (VLBI) technique, which normal operation is to record signals from quasars.

In order to develop a unique, consistent and accurate TRF, these four techniques are combined and linked together thanks to co-location sites located on the ground, where more than one space geodetic technique is located at the same site. Thereby the local ties, i.e., the vectors connecting the reference points of the individual instruments (GNSS and DORIS antennas, radio and optical telescopes), must be realized at the 1 mm level or better.

Unfortunately, one of the major deficiencies in the realization of a TRF originates from the difficulty to accurately measure the local ties between the reference points (intersection of axes of large instruments, phase centers of antennas). A second issue of the reference frame is that each technique has its own systematic effects. Thus, a second deficiency includes the (as yet unknown) systematic effects present in the observations of the individual space geodetic techniques. Finally, a third deficiency is the poor spatial distribution of co-location sites on the globe.

In order to improve this situation fundamentally, the GENESIS satellite mission will provide a highly accurate co-location of the four space geodetic techniques in space, on board the satellite with carefully and fully calibrated reference points, as illustrated in Fig. 2. Thus, GENESIS will be a calibrated co-location and reference point, fully complementary to the ground co-locations, orbiting in space and connecting all the ground stations

to one another. In this way, one can determine all the instrumental biases inherent to the different observing techniques simultaneously. This bias determination is required: (1) to avoid systematic errors, which can result in erroneous interpretations of the differences in the techniques, as well as (2) to transmit the TRF via GNSS at the precision of a millimeter to any point on the Earth that can then be used for precise positioning and navigation. The payload that will allow us to realize this co-location consists of a VLBI transmitter, a GNSS and a DORIS receiver, a passive laser retro-reflector (P-LRR) and a ultra-stable oscillator (USO) that will connect all four techniques.

Secondary goals could be reached with the addition of an active laser retro-reflector (A-LRR) and an accelerometer. The A-LRR would allow for a high precision synchronization of the onboard USO with ground clocks through time transfer by laser links from ground stations. This would provide metrology users with a common view time transfer technique, accurate at intercontinental scales. More specifically, in addition to the benefits of the already present P-LRR, the A-LRR would allow (1) to perform ground-to-space and ground-to-ground time and frequency transfers with an extended common view compared to the T2L2 and ACES missions, by taking advantage of the higher altitude of the GENESIS satellite; (2) to compare GNSS and laser time transfer techniques with an uncertainty below 100 ps; and (3) to accurately monitor the behavior of the onboard clock for precise orbitography.

An accelerometer, in combination with a well tested macro-model of the satellite's geometry and reflectance, would provide insight in non-conservative forces and their effect on the GENESIS orbit. All the mechanical and electronic properties of the platform must be characterized to within sub-millimeter tolerances. An accelerometer could be used to measure surface accelerations up to  $10^{-11} \text{ m s}^{-2} \text{ Hz}^{-1/2}$  and would (1) guarantee high-precision orbit determination and mitigating the errors mapping into the modeling of non-conservative forces; (2) allow in-orbit center of mass (CoM) determination. These characteristics are important in the determination of station positions and geophysical products such as the geocenter and Earth's orientation parameters. Another role of this accelerometer would be to serve as a position reference for the geodetic instruments on the platform in order to determine the correction of angular motion between each instrument.

The availability of high-precision measurements from the GENESIS mission will fundamentally improve the accuracy and stability of the TRF by a factor of 5–10 and will allow us to achieve the GGOS requirements. This paper reviews the science applications of the



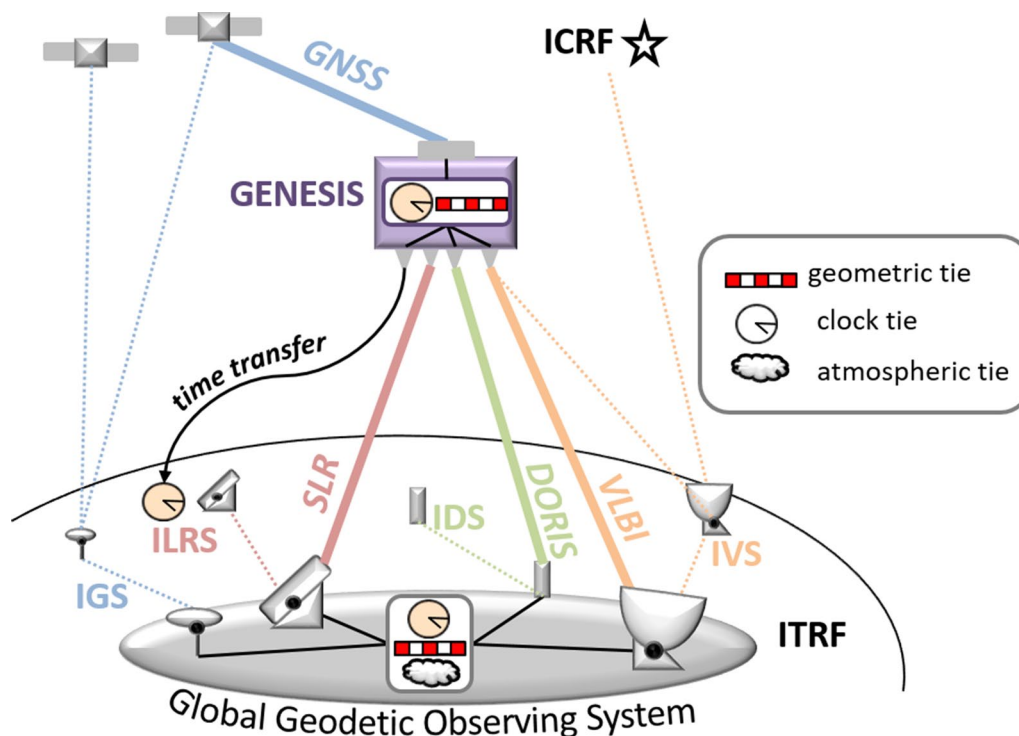

**Fig. 2** The GENESIS mission will consist of the co-location, for the first time ever, of the four space geodetic techniques (GNSS, SLR, VLBI, and DORIS) aboard a single well-calibrated satellite in Medium-Earth Orbit (MEO). This will result in a unique dynamic space geodetic observatory, which combined with the measurements of geodetic co-location sites on the ground, shall allow obtaining a significant improvement of the International Terrestrial Reference Frame (ITRF)

GENESIS mission (see also Fig. 1): improvements in the TRF geocenter and scale (section [Improvements in the ITRF geocenter and scale](#)); improvements in the celestial (inertial) frame and the Earth orientation parameters, reflecting Earth system processes (section [Unification of reference frames and Earth rotation](#)); improvements in the knowledge of the low-degree spherical harmonics of the Earth gravity field, complementary to GRACE and GRACE-FO (section [Long-wavelength gravity field](#)); improvements in global to local estimates of sea level change (section [Altimetry and sea level rise](#)); improvement in estimates of present day ice mass loss and Glacial Isostatic Adjustment (GIA) history (section [Determination of ice mass loss](#)); improved determination of the Earth’s rheology and the melting history (section [Geodynamics, geophysics, natural hazards](#)); improved quantification of surface loads due to the continental water cycle, the atmosphere and the ocean (section [Geodynamics, geophysics, natural hazards](#)); improvements in the Earth radiation budget (section [Top of atmosphere radiation budget and Earth energy imbalance](#)); improvements of the ionospheric and plasmaspheric density (section [Ionospheric and plasmaspheric density](#)); distribution of a high-accuracy

reference frame to all GNSS users for global georeferencing at the millimeter-level (section [Improvement in global positioning](#)); very accurate and consistent antenna phase center calibrations for all GNSS satellites relevant for the terrestrial scale and all positioning applications (section [GNSS antenna phase centre calibration](#)); millimeter-level precise orbit determination (POD) for altimetric, gravimetric and GNSS satellites (section [Positioning of satellites and space probes](#)); intercontinental time transfer at the picosecond level and its use to unify height systems by exploiting the gravitational redshift (section [Relativistic geodesy and time and frequency transfer](#)). Since reference frames are at the heart of metrology and all monitoring processes, the benefits from GENESIS are truly inter- and transdisciplinary and relevant for societal needs.

Moreover, an ESA Concurrent Design Facility (CDF) study has confirmed that the GENESIS Mission is feasible within the ESA FutureNAV defined program boundaries, with a target launch date in 2027. The conclusion of this study is given in section [CDF study output](#). This section is followed by a high-level description of laser ranging (section [Passive and active laser retro-reflector](#)) and VLBI transmitter (section [VLBI transmitter](#)).

## Reference frames

### Importance of reference frames

Reference frames provide the necessary absolute basis for the relative-only geodetic measurements. They are indispensable to study the dynamic Earth, and to be able to meaningfully relate changes across space and time. They are also essential for positioning and navigation in the civil society and for proper georeferencing of geospatial information. The provision of accurate and stable reference frames is one of the major tasks of geodesy.

The TRF is the realization of the TRS and is currently provided by precisely determined coordinates and velocities of physical points on the Earth's surface. The main physical and mathematical properties of a TRS (at the definition and conventions level) or of the TRF (at the realization level) include each its origin, scale, orientation, and their time evolution. The center of mass (CM) of the Earth System, or geocenter, as the realized origin of the TRF on long-term scales, needs to be accurately determined including its temporal motion (e.g., Petit and Luzum 2010). The temporal variations of the geocenter represent a component of mass change (at spherical harmonic degree one) that is not directly observable from a mass-change mission such as GRACE-FO (Wu et al. 2012). While the degree one component of mass change can be derived from a combination of GRACE data with ocean model output (e.g., Swenson et al. 2008; Sun et al. 2016, 2017) or space geodetic techniques such as GNSS, SLR (e.g., Fritsche et al. 2009; Glaser et al. 2015), a high-quality TRF solution furnished by space geodesy that allows a matching with the temporal resolution of the GRACE-FO data would be highly desired (see section [Long-wavelength gravity field](#) for more details).

Any bias or drift in the TRF components propagates into the estimated parameters based on the reference frame. It impacts for instance the measurements of vertical land motion and crustal deformation. This encompasses geological hazards but also human-induced effects (subsidence of land and coastal areas due to different effects) or even measurement of ongoing coastal erosion (National Academies of Sciences, Engineering, and Medicine 2020). Further examples are GIA or mean sea level variability in space and time (King et al. 2010; Collilieux and Wöppelmann 2011). The global sea level rise of about  $3.7 \text{ mm year}^{-1}$  (IPCC Report 2021) is numerically small, but well ascertained within the range of measurement accuracy. In addition, an acceleration in the rate of sea level rise has also been observed (e.g., Nerem et al. 2018; Veng and Andersen 2021). In areas at risk of flooding, the global mean sea level rise is a main topic of public dispute and political decisions. For its accurate monitoring and reliable prediction, the accuracy and long-term stability

of the TRF should be at least one order of magnitude better than the observed effects, leading to the GGOS accuracy and stability goals (see, e.g., Wöppelmann and Marcos 2016).

As stated in the introduction, the importance of accurate and stable reference frames was highlighted by the UN (United Nations General Assembly 2015). The implementation of the GGRF is intended to support the increasing demand for positioning, navigation, timing, mapping, and other geoscientific applications. Indeed, the GGRF is essential for a reliable determination of changes in the Earth system, for natural disaster management, for monitoring sea level rise and climate change, and to provide accurate information for decision makers. Furthermore, due to globalization and interoperability requirements, there is a growing demand for spatial data infrastructure (see, e.g., UN-GGIM 2022). Precise spatial information is needed in many areas beneficial to society, including transportation, construction, infrastructure, process control, surveying and mapping, and Earth sciences, and is especially important for monitoring progress towards the UN Sustainable Development Goals (SDGs) (UN SDGs' Website 2022) (see, e.g., UN-GGIM 2021).

### Present status of the terrestrial reference frame realization

The actual realization of the International Terrestrial Reference System (ITRS), accessible to the users, is the ITRF. The computation of the ITRF is based on a rigorous combination of different TRF solutions provided by the four space geodetic techniques (DORIS, GNSS, SLR, VLBI), as well as the terrestrial local tie measurements conducted at co-location sites where two or more geodetic instruments operate. Local ties are the relative coordinates between the reference points of the individual instruments. They are crucial to connect the exact points of the observations of the different techniques in the ITRF construction. The ITRF is provided to the users in the form of station positions at a reference epoch and corresponding linear station velocities, and since the ITRF2014, parametric models for sites subject to major earthquakes (Altamimi et al. 2016). The ITRF2020 was published in April, 2022 (ITRF Website 2022). It now provides seasonal signals caused mainly by loading effects, expressed in both the Earth's CM as sensed by SLR, but also in the center of figure (CF) (Altamimi et al. 2021, 2022).

The ITRF long-term origin is defined by SLR, the most accurate satellite technique in sensing the Earth's CM. The ITRF long-term scale, however, is defined by an average of the SLR and VLBI intrinsic scales. The consistency of these scales still needs to be improved, since both techniques are subject to systematic errors and other

technical limitations, such as time and range biases for SLR, antenna deformation for VLBI, etc. The GENESIS mission will help to solve these inconsistencies. The ITRF orientation and its time evolution are defined to be the same for the successive ITRF realizations.

Although the ITRF is the most accurate TRF available today, it still needs at least an order of magnitude of improvement in order to meet the scientific challenges of observing Earth system variability. The ITRF is not only a fundamental standard for Earth science applications, but its elaboration, using extensive data analysis, also allows to evaluate the level of consistency between space geodetic techniques and to assess the systematic differences that are a major limiting factor in the ITRF accuracy.

The analysis of the input data submitted to the latest ITRF version, ITRF2020 (ITRF Website 2022), was the occasion to re-evaluate the current level of consistency among the four main space geodetic techniques and their strengths and weaknesses. There are still a number of factors that limit the ITRF accuracy, as shown (or reconfirmed) by the ITRF2020 results.

Although the ITRF2020 long-term origin is defined solely by SLR, weaknesses in its realization include the poor number and geometry of SLR stations in operation today: the number of the most prolific SLR stations does not exceed 16, and not all of these stations have the same level of performance. The only internal evaluation that can be made is the level of agreement between ITRF2020 and previous ITRF versions, namely ITRF2005, ITRF2008, and ITRF2014 whose origins were also defined using SLR data submitted in the form of time series. ITRF2020 results indicate that the agreement in the origin components, with respect to the past three ITRF versions, is at the level of 5 mm in offset and 0.5 mm/year in rate, values that are still far away from the science requirements.

Counting the number of ITRF2020 co-locations between VLBI, SLR and DORIS, 11 VLBI–SLR, 12 VLBI–DORIS and 11 SLR–DORIS ties exist. These numbers of co-locations are too small to provide a reliable combination of these three techniques alone. The GNSS network is fundamental in determining the ITRF by connecting the three other techniques to GNSS, since almost all SLR and VLBI stations, and about two-thirds of the DORIS stations are co-located with GNSS. Only 32 % to 50 % of these co-location sites (with time spans > 3 years) have an agreement between the terrestrial tie vectors and the space geodetic estimates of better than 5 mm in the three components. It is likely that most of the tie discrepancies (differences between terrestrial ties and space geodetic estimates) are caused by systematic errors in the techniques. The poor spatial distribution of co-location sites is also a major limiting factor for the present accuracy of

the terrestrial reference frame realization, which would be tackled by the GENESIS mission.

The ITRS Center of the International Earth Rotation and Reference Systems Service (IERS), hosted by the Institut national de l'information géographique et forestière (IGN) France, is responsible for the maintenance of the ITRS/ITRF and the official ITRF solutions. Two other ITRS combination centers are also generating combined solutions: Deutsches Geodätisches Forschungsinstitut at Technische Universität München (DGFI-TUM; Seitz et al. 2012, 2022) and Jet Propulsion Laboratory (JPL; Wu et al. 2015; Abbondanza et al. 2017). These ITRS realizations provide a valuable possibility to validate official ITRF solutions and thus help to increase the reliability of the ITRF.

GENESIS, as a fully calibrated satellite-based platform, will provide a complementary co-location of the four techniques in space, a “core co-location site in space”, as an optimal supplement to the existing co-locations on ground. This is essential to identify and potentially reduce the systematic errors and/or determine whether the errors come from the terrestrial ties or from the space geodetic estimates.

The GENESIS mission will improve our ability to simultaneously identify the systematic errors and to consequently improve the ITRF accuracy and stability, particularly the origin and the scale that are the most critical parameters for scientific applications. GENESIS will leverage the crucial existing ground-based co-location network, allowing the development of future-proof terrestrial reference frames.

#### **Improvements in the ITRF geocenter and scale**

We define herein the geocenter motion as the motion of the center of mass (CM) of the whole Earth (solid body and fluid envelope) with respect to the geometrical center of figure (CF) of its deformable terrestrial crust. This motion is strongest at the annual frequency (2 mm to 3 mm in the equatorial plane and up to 5 mm in the direction of the polar axis) where it mostly reflects non-tidal fluid mass redistribution on the Earth's surface. The long-term secular variation represented by a linear rate is believed to be less than 1 mm/year (Métivier et al. 2010, 2011). In addition, atmospheric, hydrologic and oceanic masses cause deformations of the Earth's surface due to loading effects (Wu et al. 2012). The space geodetic stations tied to the crust, thus, show variations of their position (mainly in the height component) due to variations of the loading effects caused by major water and atmosphere mass transport occurring over large regions. These position variations lead to changes in the CM with respect to the CF. Determining the variations of the geocenter is therefore important for understanding



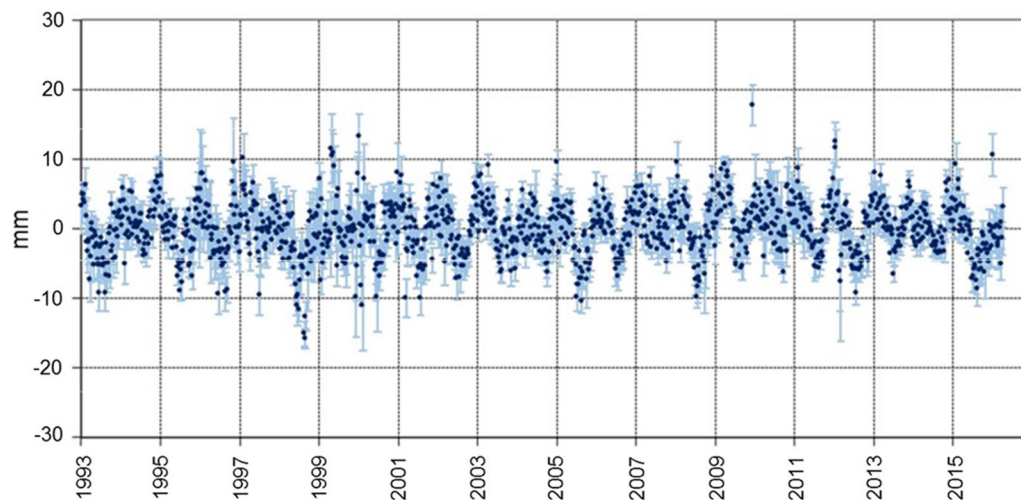

**Fig. 3** SLR-derived geocenter motion, X component (ILRSA combined solution, ASI/CGS)

the long-wavelength changes in the distribution of mass within the Earth's system (see section [Long-wavelength gravity field](#)).

The geocenter motion is accessible by ground station observations (tied to the crust's CF), used to observe the natural orbital motion of the satellites about the Earth's CM. Yet, space geodetic observation of the geocenter motion is still in its infancy. Independent solutions derived using different techniques have systematic differences as large as the signal level. Estimating geocenter coordinates is one of the most demanding applications of high-precision geodetic techniques due to the current precision of the geodetic data, and the nature and magnitude of different types of systematic error.

Up to now the geocenter motion is traditionally measured by SLR using the observations to geodetic satellites (see Fig. 3). The geodetic satellites such as LAGEOS or LARES are considered to be well suited for determining the geocenter motion owing to their mission characteristics, such as orbit altitude, low area-to-mass ratio, and thus minimized non-gravitational orbit perturbing forces. Until now, determination of geocenter coordinates based on the SLR observations to active Low-Earth Orbit (LEO) satellites was limited because of issues in non-gravitational force modeling acting on LEO satellites. In principle, the geocenter coordinates should be well determined from any satellite mission that is continuously observed and has processed orbits of superior quality. Therefore, GENESIS can introduce an alternative for the geocenter recovery w.r.t. passive geodetic satellites.

However, the accuracy of SLR data is extremely sensitive to the presence of observational biases therein, e.g., range biases and network effects (Collilieux et al. 2009), affecting also the geocenter determination. Determining

these biases would necessitate the use of an independent geodetic technique. Range biases are calculated in SLR processing as additive constants in the modeled range, which should be in essence independent of the epoch of observation and measurement conditions, such as station elevation/azimuth angles, or measured range. However, the range biases not only compensate for ranging machine errors, but also absorb the modeling errors such as satellite center of mass offsets, orbit force model deficiencies, or tropospheric delay (Appleby et al. 2016; Luceri et al. 2019; Drożdżewski and Sośnica 2021). The presence of ambiguous range biases corrupts the estimation of fundamental geodetic products including site coordinates, the terrestrial reference frame scale and origin (geocenter motion), and geocentric gravitational constant (GM) (Couhert et al. 2020). GENESIS can expand our knowledge on the range biases aiming to improve the consistency of SLR geodetic products with the other space and satellite geodetic techniques.

GNSS-based determinations of the geocenter motion suffer from orbit modeling deficiencies due to an inherent coupling of the GNSS orbit dynamic parameters: the GNSS geocenter Z-component is strongly correlated with the parameterization of the Solar Radiation Pressure (SRP) (Meindl et al. 2013). With only limited a priori knowledge about the non-conservative forces acting on GNSS satellites, we must incorporate additional empirical orbit parameters into the solution, i.e., Empirical CODE Orbit Model or Jet Propulsion Laboratory GSPM. The errors in the orbit model, as well as the correlations between the estimated parameters (Rebischung et al. 2014), introduce spurious orbit-related signals in the GNSS-based geocenter motion estimates (Meindl et al. 2013; Rodriguez-Solano et al. 2014). The consistency

between GNSS-based and SLR-based geocenter motion estimates can be improved by using satellite macro-models (Zajdel et al. 2021). Another way to improve the GNSS-based geocenter motion is the combined multi-GNSS processing (Scaramuzza et al. 2018) or the inclusion of Galileo satellites on an eccentric plane (Zajdel et al. 2021).

Other approaches (Haines et al. 2015; Männel and Rothacher 2017; Kuang et al. 2019; Couhert et al. 2020b) demonstrated the possibility to observe the geocenter motion with GNSS tracking data in addition to LEO satellites (e.g., GRACE, GOCE, or Jason-like satellites), which helped to reduce the errors coming from the GNSS-only determination. Such methods would be well suited to derive GNSS-based geocenter time series with GENESIS. The synchronization of the GENESIS onboard USO thanks to an A-LRR would allow a modeling of the clock instead of estimating clock correction parameters for each epoch. This is expected to improve the capability for accessing the geocenter.

DORIS as the third satellite technique is in principle also sensitive to the CM of the Earth. DORIS benefits from the well-distributed network of stations, but trails other geodetic techniques in terms of the quality of station coordinates because of the limitation of non-gravitation perturbing forces modeling and precise orbit determination of active satellites equipped with DORIS receivers. Moreover, the problems mentioned for GNSS also apply to the DORIS system. Yet, SRP modeling error on the Jason-type satellites can be identified and mitigated without compromising the Z geocenter estimate (Couhert et al. 2018).

VLBI in its current application is a purely geometric technique, thus, it has no connection to the Earth's gravity field (including the CM of the Earth). VLBI can currently be connected to the satellite techniques only via the station network and the local ties, and is not able to contribute to the geocenter determination. However, numerical simulations demonstrated that geodetic VLBI is able to observe geocenter motion using observations of Galileo satellites (Klopotek et al. 2020), suggesting that the GENESIS mission will enable a VLBI-contribution to the estimation of geocenter motion.

For the current ITRS, the origin is assumed to be aligned to the long-term Earth's CM. In parallel, the geopotential models assume that on average the Earth's CM is at the center of the geodetic network (i.e., zero values for degree-1 geopotential coefficients). Thus, the importance of an accurate geocenter motion cannot be overstated. Not accounting properly for the geocenter motion affects both satellite altimetry, precise orbit determination and satellite-derived estimates of the change in regional mean sea level. Because of climate change, and

the need to both measure the change in the ice sheets and understand their impact on sea level and global fluid mass redistribution, we must explore strategies to better observe and model these subtle variations in the Earth's geocenter.

GENESIS is a unique opportunity to properly calibrate the space geodetic techniques against each other. By this, GENESIS helps to improve our understanding of the aforementioned systematic differences between geocenter solutions derived using independent techniques, allowing the best possible accuracy in the recovery of the geocenter time series. In addition, the VLBI tracking of GENESIS is a unique opportunity to attach also the VLBI technique to the CM of the Earth. As a result, the TRF determined from the GENESIS measurements will realize the origin located in the CM of the Earth consistently for all four space geodetic techniques for the first time.

The same reasoning holds true for another fundamental property of the ITRF, i.e., the scale that is currently determined by means of SLR as well as by VLBI data analysis. The scale is defined in such a way that there exists no scale factor and no scale factor rate with respect to the mean of VLBI and SLR long-term solutions as obtained by stacking their respective time series. But similar to the problems mentioned related to geocenter, SLR and VLBI suffer from systematics also affecting the scale, e.g., unknown range biases for SLR stations and unknown antenna deformations for VLBI. Due to the very limited number of co-located SLR–VLBI stations on the Earth's surface and due to the lack of a common satellite, the agreement of the SLR- and VLBI-derived scales is difficult to assess, and the two techniques cannot be well calibrated against each other. In ITRF2020 the scale discrepancy between SLR and VLBI could be significantly reduced, however only selected VLBI sessions until 2013.75 and SLR observations from 1997 until 2021.0 were used due to trends and jumps with unknown nature. GENESIS will probably help to reveal the reasons for them and improve the scale realization significantly.

Undisclosed information about the ground calibrations of the satellite antenna Phase Center Offsets (PCO) prevented the use of GNSS for the scale determination. Thanks to the release of the Galileo phase center calibrations for both the ground (receivers) and space (satellite antennas) segment (GSA Website 2017), GNSS became a new potential contributor to the realization of the terrestrial reference frame scale of the future ITRF releases. Villiger et al. (2020) reported that the Galileo scale difference w.r.t. ITRF2014 is 1.4 ppb at the epoch of 1st January 2018. The information about the satellite phase center calibrations, which have been published in 2019 by CSNO (China Satellite Navigation Office) for the BeiDou satellites, opened up a space for the second GNSS

able to provide an independent realization of the terrestrial reference frame scale (Zajdel et al. 2022). However, some results indicate that the scales derived with BeiDou-released and Galileo-released satellite phase center calibrations are not consistent, and the bias between both reaches 1.8 ppb (Qu et al. 2021).

Studies have already demonstrated that the SLR-based scale can be well transferred to the GNSS network, if a satellite is used as co-location platform (Thaller et al. 2011, 2014). In these studies, the GNSS satellites tracked by SLR were employed as co-location platforms, however, being limited to GNSS and SLR only. At the moment, DORIS is unable to deliver reliable scale information due to uncalibrated or not well-calibrated antenna phase center locations and variations (for ground stations as well as satellites).

GENESIS will enlarge the satellite co-location to all four space geodetic techniques allowing cross-calibration of all techniques to determine a homogeneous scale. Thanks to the common platform on board GENESIS, the scale will be transferable to all techniques, resulting in the best possible materialization of the ITRF.

#### Unification of reference frames and Earth rotation

Geodetic VLBI uses the emission by extragalactic radio sources with well-defined positions in the sky. If it is possible to transmit a quasar-like signal from an orbiting platform with a precise orbit, then we would be able to better understand biases between the CRF realized with positions of extragalactic radio sources and dynamical realizations by satellite orbits.

CRF, TRF, and the Earth Orientation Parameters (EOP) that describe the transformation between these two frames are fundamental for any kind of positioning on the Earth and in space and provide most valuable information about the Earth system. The International Celestial Reference System (ICRS) is a quasi-inertial reference system defined by extragalactic radio sources, mostly quasars, billions of light years away, and is realized as International Celestial Reference Frame (ICRF) with a set of quasar coordinates with a noise floor of about  $30 \mu\text{as}$  (Charlot et al. 2020). The positions of a set of globally distributed radio telescopes are determined using the difference in the arrival times of the signals at the different telescopes (Sovers et al. 1998).

The VLBI technique provides direct access to the ICRS and is the best technique for observing the full set of EOP. Specifically, VLBI is the only technique able to determine the position of the celestial intermediate pole in the ICRF, expressed as celestial pole offsets to a conventional precession/nutation model, and the Earth's rotation angle, typically referred to as Universal Time or

UT1–UTC. Table 1 summarizes the parameter types and the space geodetic techniques contributing to their determination. The table also shows the parameters that can be used for a co-location of the techniques, both, on the surface of the Earth and in space. Satellite techniques rely on measurements between stations on the Earth's surface and satellites, whose orbits are subject to various gravitational and non-gravitational forces (e.g., SRP). As a consequence, SLR, GNSS and DORIS depend on a reference frame that is dynamically realized by satellite orbits and thus completely different in nature from the kinematic realization of the ICRS by VLBI. Presently, the only physical connection between the VLBI frame and frames of SLR, GNSS and DORIS is via the local ties on the ground; however, these ties reveal significant discrepancies with respect to the terrestrial frames delivered by the individual space geodetic techniques.

GENESIS will link all the technique frames in space (see bold emphasis in Table 1). This concept and its realization will represent a breakthrough in improving the accuracy and consistency of the reference frame. In addition, GENESIS will also directly link the dynamical satellite frame to the quasars using differential VLBI observations (D-VLBI), i.e., differencing the radio signal emitted by GENESIS with the signals from the fixed radio sources, the quasars.

Another issue of the ICRF and ITRF is that the realizations of the frames are independent of one another. The ITRF is fixed when computing the ICRF and vice versa. The approach leads to inconsistencies that map into the EOP that connect the two frames. The IAG Resolution 2 at the International Union of Geodesy and Geophysics (IUGG) General Assembly in Melbourne (2011) recommends that the highest consistency between the ICRF, the ITRF and the EOP should be a primary goal in all future realizations of the ICRS (IUGG Website 2022). Although the IUGG recommendation has not yet been fulfilled, research in this direction has been initiated and simultaneous estimation of CRF, TRF, and EOP have been achieved (Seitz et al. 2014; Kwak et al. 2018). At the international level, this topic is being addressed by the ICRF3 Working Group of the International Astronomical Union and by Sub-Commission 1.4 on the Interaction of Celestial and Terrestrial Reference Frames of the IAG. The common adjustment of the celestial and terrestrial reference frames and EOP will strongly benefit from new observations provided by GENESIS.

In summary, to strengthen the link between VLBI and the satellite techniques, it is imperative to use improved and better ties than what is currently available, i.e., the local ties at the relatively few VLBI/GNSS co-located

**Table 1** Classification of estimated parameters derived from space geodetic techniques

Classification	Type	Parameter	VLBI	GNSS	SLR	DORIS	LLR
Common, global	Satellite orbits	GNSS orbits	(✓)	✓	(✓)		
		LEO orbit		✓	✓	✓	
		LEO clock corrections		✓		(✓)	
		<b>GENESIS orbit</b>	✓	✓	✓	✓	
		<b>GENESIS clock corr.</b>	✓	✓	✓	✓	
	EOP	Pole coordinates	✓	✓	✓	✓	(✓)
		UT1	✓				(✓)
		LoD	✓	✓	✓	✓	(✓)
		Nutation	✓				(✓)
	Gravity field	Nutation rates	✓	✓	✓	✓	(✓)
		Earth center of mass			(✓)	✓	(✓)
	TRF	Low degree coefficients			✓	✓	✓
		Scale	✓	(✓)	✓	(✓)	(✓)
Common, local	Atmosphere	Ionosphere parameters	✓	✓		✓	
		Troposphere parameters	✓	✓	(✓)	✓	
	TRF	Station positions	✓	✓	✓	✓	(✓)
		Station velocities	✓	✓	✓	✓	(✓)
	Time–frequency	Station clock corrections	✓	✓	(✓)	✓	(✓)
Technique-specific	CRF	Quasar positions	✓				
	Instrumental	Moon orbit					✓
		GNSS clock corrections			✓		
		Range biases			✓	✓	

Co-location in space with GENESIS is marked in bold (adapted from Männel 2016)

sites. Initial work with dedicated space tie satellites demonstrated the feasibility of this approach, see simulations by Anderson et al. (2018) or Klopotek et al. (2020) and real observations to the APOD-A satellite by Hellerschmied et al. (2018). Dedicated VLBI beacons transmitting at VLBI frequencies on a well-calibrated satellite such as GENESIS will enable the observation of satellites with VLBI radio telescopes.

Moreover, GENESIS will not only combine GNSS and VLBI, but also SLR and DORIS. Table 1 illustrates that a rigorous combination of all the observation techniques and of as many of the common parameters as possible should be envisaged to overcome the weaknesses of the individual space geodetic techniques. GENESIS is a crucial element for improving the relationship between the reference frames of VLBI and the satellite-based techniques.

The time variations of Earth rotation parameters contain subtle information about the mass transport in the system made up of the solid Earth, the external fluid layers, and the outer and inner core. An accurate determination of EOP has long been at the origin of challenging studies related to the Earth's interior: e.g., insights into the coupling mechanisms at core–mantle and core–inner core boundaries by inversion of nutation data (Dehant

et al. 2017) and to climate: e.g., mechanisms of angular momentum exchange between the solid Earth and the atmosphere–ocean system, link with climate change (Dickey et al. 2011). In addition, the improvement of the VLBI CRF (Charlot et al. 2020) contrasted with the optical data from the ESA's Gaia astrometry mission (Gaia Collaboration et al. 2018) will allow to shed a new light on the physics of active galactic nuclei and quasars that will benefit from an improved stability of the radio frame currently limited to 0.03 mas.

Given that GENESIS will provide a direct link between the kinematic (VLBI, quasar-based) and dynamic (satellite-based) reference frames and is expected, thus, to improve the consistency of the TRF, CRF, and EOP realizations, all the above scientific domains will be positively impacted, extending thus the challenges of GENESIS well beyond its first scope.

The continuous tracking of the GENESIS satellite and the connection to GNSS satellites will allow for mitigation of some technique-specific systematic effects currently observed in the GNSS-derived Earth rotation parameters. These errors come from constellation repeatability and orbital resonances between Earth rotation and satellite revolution period, as well as draconitic errors due to the limitations in the precise orbit determination



(POD) of GNSS satellites (Zajdel et al. 2020). The integrated adjustment of low-orbiting GENESIS and GNSS constellations could allow for the mitigation of technique-specific systematic effects observed in the polar motion and length-of-day variations, and thus, improve the quality of EOPs.

The sub-daily Earth rotation can be monitored using space geodetic techniques. However, the current empirical sub-daily EOP models derived from GNSS or VLBI differ from the geophysical models derived from ocean tides (Zajdel et al. 2021). The sub-daily changes of the pole position are mainly caused by ocean tides, and to a smaller extent, by the atmosphere. However, GNSS cannot provide suitable values of some tidal constituents equal to half and one sidereal day due to the similar revolution period of the satellites.

GENESIS, with its completely different orbit characteristics than the GNSS satellites, will introduce an ever bigger step in this direction. Therefore, the sub-daily polar motion, libration terms, or sub-daily length-of-day variations will be better understood. Due to the continuous tracking of GENESIS, the derivation of sub-daily variations will be possible based on integrated observational techniques. Moreover, GENESIS will help in deriving sub-daily variations of the pole caused by the mass redistribution in the atmosphere, which are currently affected by large determination errors. Therefore, GENESIS will pave new opportunities for better understanding the sub-daily Earth rotation and relate their causes to the geophysical processes.

## Benefits for Earth sciences

### Long-wavelength gravity field

Changes in the Earth's gravity field provide information about the redistribution of mass within the Earth system. These changes are measured with exquisite precision by dedicated gravity satellites such as GRACE-FO. Historically, geodetic tracking data (primarily SLR data, but also DORIS and GNSS) has also been used to provide information about the long-wavelength (low-degree) time-variable gravity field (e.g., Cheng and Ries 2018; Cerri et al. 2013; Richter et al. 2021; Sošnica et al. 2015; Bloßfeld et al. 2018). Due to issues with the accelerometers and possibly with tidal aliasing the C20 and C30 solutions from GRACE and GRACE-FO so far have been supplied by SLR (Loomis et al. 2019, 2020). Because of these accelerometer issues, it remains important to monitor and inter-compare GRACE and GRACE-FO based solutions with independent solutions (e.g., Chen et al. 2021), where that is possible at the longest wavelengths.

GENESIS can provide independent estimates of the low-degree Stokes coefficients based on all geodetic techniques. SLR studies and simulations showed that adding

one satellite to a solution based on five SLR satellites may significantly improve the determination of the low-degree spherical harmonics of the Earth gravity field (Bloßfeld et al. 2018; Kehm et al. 2018). The main improvements were seen in C10, C20, and C40, the standard deviations of which are improved up to 30 %. Also, observations of GENESIS with VLBI would strengthen the integration of the Earth geometry, rotation and gravitational field. The Stokes coefficients are common parameters to all techniques such as a subgroup of the EOP, namely the terrestrial pole coordinates and its first derivatives (see Table 1).

Moreover, GENESIS will be of benefit in the refinement of the Earth GM, which helps to define the scale of the TRF. The current value of  $3.986004415 \times 10^{14} \text{ m}^3 \text{ s}^{-2}$  was determined by Ries et al. (1992) and has an uncertainty of the order 2 ppb, corresponding to  $\pm 2 \text{ cm}$  in the absolute radial position of high-orbiting GNSS satellites. Some recent work has suggested possible solutions closer to  $3.986004418 \times 10^{14} \text{ m}^3 \text{ s}^{-2}$  (Couhert et al. 2020a).

An exciting prospect is that the precise tracking on GENESIS by multiple geodetic techniques, together with SLR tracking to the satellites LARES and LARES-2 could lead to improve Earth GM determination with a much lower uncertainty.

### Altimetry and sea level rise

Measurements of sea level rise over the last century (and more) have been derived from observations of sea level change as recorded by a global distribution of tide gauges. Tide gauge observations are relative observations, i.e., the changes in sea level are provided relative to the land to which they are attached. But processes such as glacial isostatic adjustment and tectonics cause the land to move in the vertical direction. To measure sea level change in a global reference frame, the tide gauges are geodetically tied to the TRF using co-located GNSS stations. Thus, the ability to observe contemporary sea level rise at global or local scales is limited by the stability of the TRF, i.e., the metrological basis for the determination of the vertical motions of stations on the Earth's surface. The reference frame stability is one of the major error sources in the determination of global and regional sea level rise (Beckley et al. 2007; Blewitt et al. 2010; Blazquez and Meysignac 2022), as illustrated in Fig. 4.

As recognized by GGOS, sea level poses the most stringent requirements on the accuracy and stability of the TRF. In addition to the tide gauge problem outlined above, precise satellite orbits in a highly stable and accurate TRF are crucial to observe sea level using satellite radar altimetry. Since the launch of the TOPEX/Poseidon satellite in 1992, followed later by the Jason

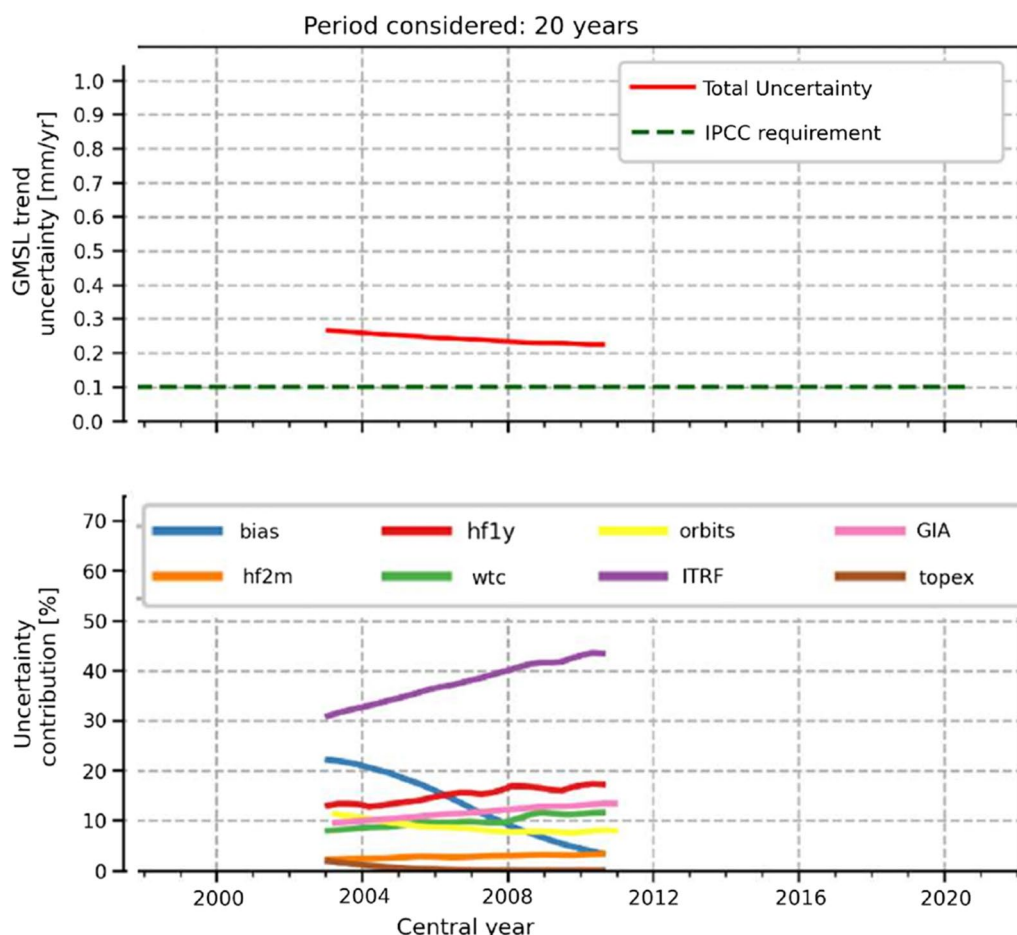

**Fig. 4** Total uncertainty in the global mean sea level (GMSL) trend and individual contributions (Blazquez and Meyssignac 2022). The uncertainty coming from the International Terrestrial Reference Frame (ITRF) is clearly the major contribution, which implies a total uncertainty currently well over the Intergovernmental Panel on Climate Change (IPCC) requirement. Adapted from Ablain et al. (2019)

and Sentinel series of altimetry satellites, sea level variations have been routinely observed from space while tide gauges are also required to detect drifts in satellite radar altimetry data (International Altimetry Team 2021). Moreover, it is acknowledged that the continuous improvement of satellite POD, through the precision and quality of the tracking systems, reference frame, Earth Rotation Parameters, and static and time-variable geopotential models are crucial in order to reach the specifications of altimetry missions (International Altimetry Team 2021).

To be useful in long-term sea level studies, sea level and the vertical land motion should be measured in a reference frame at least one order of magnitude more accurate than the contemporary climate change signals of 1 mm/year to 3 mm/year observed on average in sea level records, either from tide gauges or satellite radar altimetry, leading to the GGOS accuracy and stability goals.

The GGOS stability goal of 0.1 mm/year of global and regional sea level variations over several decades can only be achieved by more accurate and more stable reference frame realizations, which is the primary goal of the GEN-ESIS mission.

**Determination of ice mass loss**

Direct local observations and space geodetic techniques including gravimetry, radar and laser altimetry, optical and synthetic aperture radar imagery and GNSS, have provided clear evidence for large changes in the world’s glaciers and ice sheets, in response to present climate change (e.g., Shepherd et al. 2018, 2020; Millan et al. 2022; Fox-Kemper et al. 2022). However, despite the extensive literature on the subject, the ice mass balances over the different ice sheets and smaller glacier regions are associated with large uncertainties (e.g., Cazenave et al. 2018; Métivier et al. 2010; Khan et al. 2015). In particular, the question of possible local accelerations of ice

mass loss in Greenland is still open (e.g., Velicogna and Wahr 2013; Velicogna et al. 2014, 2020).

Direct observations of glaciers and ice sheets are local and only partially resolved in time, while space observations provide insights into the cryosphere evolution at global scale and at regular timescales. Space altimetry (e.g., ICESat, ICESat-2, CryoSat-2 missions; e.g., Felikson et al. 2017; Sørensen et al. 2018) gives high resolution observations of the ice surface elevation, with a relatively poor time resolution. These techniques, unfortunately, cannot provide directly ice mass balances because the mean density of the ice column is not known and may largely vary locally due to compaction processes within the firn layers of ice sheets (Medley et al. 2020). Additional information is therefore mandatory, generally based on compaction assumptions and climate models (Huss 2013; Kuipers Munneke et al. 2015; Medley et al. 2020). Space gravimetry from GRACE and GRACE-FO missions provides direct information on mass variations, on a monthly basis, but with a spatial resolution of a few hundred kilometers (Tapley et al. 2004; Landerer et al. 2020). However, the various contributions from the solid Earth and the surface layers cannot be separated with space gravimetry data alone. These other signals have to be removed before glacier and ice sheet signals can be retrieved, specially in the regions where these signals are of the same order of magnitude or even higher (Wouters et al. 2019). Removing these signals implies adding new information from models as for the GIA or observations and adding new sources of uncertainty. In particular, the separation between the recent ice melting signals and the GIA induced by the last glacial period (e.g., Whitehouse et al. 2021; Peltier et al. 2015; Lambeck et al. 2014), or by the little ice age (Kjeldsen et al. 2015), is also a complex issue. However, GIA modeling approaches today depend also on space geodetic observations (e.g., Argus et al. 2021; Khan et al. 2016) and therefore would benefit from a better estimation of ITRF parameters. Of particular interest is the uncertainty associated with the GIA in Antarctica, responsible for 20 % of the uncertainty in the Antarctica mass change for the period 2005–2015 (Blazquez et al. 2018).

Space geodetic techniques, in particular GNSS, provide also useful information on ice sheets and glaciers evolution, by showing the ground deformation at geodetic stations induced by local ice mass changes (e.g., Khan et al. 2016; Whitehouse et al. 2019). However, GNSS-based velocities are sensitive to very local changes in the ice sheets, which make it difficult to confront with more global approaches, such as space altimetry and gravimetry (e.g., Khan et al. 2010). Other techniques are also promising for monitoring ice caps evolutions, such as radar interferometry. A combination of all techniques

is today the best way for monitoring ice sheet changes, however discrepancies are clearly evidenced (Shepherd et al. 2018, 2020).

All space geodetic techniques rely on the availability of a precise and stable terrestrial reference frame such as ITRF2014 and ITRF2020 (see section [Present status of the terrestrial reference frame realization](#); Altamimi et al. 2016). The stability over time of such a frame may inevitably impact all kind of geophysical interpretations that are deduced from geodetic observations. It was shown that it is not possible to ensure consistency between the ITRF2008 origin and the mean CM at a level better than 0.5 mm/year (Wu et al. 2011). These inconsistencies remain in ITRF2014 and cannot be properly explained by geophysical models (Riddell et al. 2017). Moreover, CM motions are today more than ever difficult to estimate with precision and stability, because they are also impacted by climate change. It has been shown that the global ice sheet melting may induce today an accelerated CM motion, possibly up to ~1 mm/year with respect to the CF, towards south pole along the Earth’s rotational axis (e.g., Métivier et al. 2010, 2011, 2020).

An error of a few tenths of mm/year in the frame origin stability estimation is well known to have a large impact on the orbit calculations of satellites and in the water mass redistribution on the surface (see Table 2). Nowadays uncertainty in the long-term trends in the geocenter motion of ±0.3 mm/year leads to uncertainties in the Antarctica mass change of 18 Gt/year (Wu et al. 2012; Blazquez et al. 2018).

As mentioned before, we expect that GENESIS will improve the determination of the reference frame. Such a stable ITRF should drastically reduce the frame dependency of ice mass balance estimations.

**Table 2** Uncertainty in the water mass change induced by an uncertainty of 1 mm in each axis of the geocenter motion. Note that cubic kilometers (km<sup>3</sup>), gigatons (Gt) and mm Sea Level Equivalent (mm SLE) are common units used to describe an amount of water mass, usually assuming the density of the water as the density of freshwater: 1 km<sup>3</sup> ≈ 1 Gt 1 × 10<sup>12</sup> kg ~ 1/360 mm SLE

	Ocean mass mm SLE	Greenland Gt	Antarctica Gt
X	0.5	<1	< 1
Y	0.3	<1	7
Z	0.6	11	68

Updated from Blazquez et al. (2018)

### Geodynamics, geophysics, natural hazards

Post-glacial rebound, also known as GIA, is the delayed viscoelastic response of the solid Earth to unloading caused by the melting of ice after the last glacial maximum ( $\sim 13,000$  years ago). The induced vertical uplift can reach more than 1 cm/year in North America and Fennoscandia, where the ice thickness was the largest. This long-term deformation depends on the ice coverage (both extent and thickness), the melt history, and the viscoelastic properties of the Earth's mantle. GIA models currently are built using various observations, from moraines to relative sea level variations, Earth's oblateness variations, length-of-day variations, etc. Vertical rebound velocities from GNSS permanent stations provide an independent but also absolute observation of the GIA in high latitudes (where there is no ice today), and improve our knowledge of the Earth's rheology at long timescales. Improving GIA models (Earth's rheology and ice history) requires better estimates of uplift rates which can only be achieved with a more precise and stable reference frame (see, e.g., Métivier et al. 2020).

On shorter timescales, GNSS stations also record Earth's elastic response to surface mass redistribution within the climatic system (mainly continental water storage, atmosphere and ocean). Dense networks of permanent GNSS stations can now be used to derive soil and snow water content at seasonal timescales, but has also provided evidence for extreme droughts, especially in California (see, e.g., Argus et al. 2014; Fu et al. 2015; Jiang et al. 2022). GNSS time series from dense networks can be used to refine the information provided by space gravimetry missions (GRACE and GRACE-FO) at longer spatial wavelengths (see section [Long-wavelength gravity field](#)). Amplitude and spatial extent of surface water mass variations can be inferred from both vertical and horizontal deformation measurements. In particular, horizontal displacements help to refine the determination of the location and the spatial extent of the load. This elastic Earth's response to surface loads has to be separated from a longer-term deformation, which can only be obtained with a more accurate and stable reference frame as proposed by the GENESIS project.

Observed ground movements at the Earth surface are manifold and related to a whole set of processes. Common and essential to all these movements are detection and monitoring to execute and develop risk assessment strategies. Natural hazards, such as earthquakes, volcanic hazards or landslides may be preceded by small displacements of the Earth's surface. Dense networks of GNSS stations in Japan, the western United States, and South America have been installed to monitor these surface displacements, related to the seismic cycle. In particular, pre-earthquake surface deformation can be related to the

stress and the state of stress in the lithosphere. Surface displacements from increasing stress in the lithosphere may have small amplitudes. Therefore, a very stable and precise reference frame is required to be able to interpret these observations as reliable prediction tools for the onset of hazards versus errors in the techniques themselves.

### Top of atmosphere radiation budget and Earth energy imbalance

The radiative imbalance at the Top Of the Atmosphere (TOA) is the most fundamental metric to estimate the status of climate change. At equilibrium, the climate system receives as much visible energy from the sun as it emits infrared radiation towards space. Over the last decades, greenhouse gases and aerosol concentrations have been increasing in the atmosphere, blocking longwave radiation and leading to an imbalance at TOA between the incoming solar radiation and the outgoing longwave radiation (Hansen et al. 2011; Trenberth 2014). This imbalance, known as the Earth Energy Imbalance (EEI), is about  $0.5 \text{ W m}^{-2}$  to  $1 \text{ W m}^{-2}$  (e.g. Loeb et al. 2018). It characterizes the general heat uptake of the climate system that is responsible for current climate change. It is particularly challenging to estimate the EEI from TOA radiation fluxes since it is 2 orders of magnitude smaller than the mean incoming solar radiation and the mean outgoing longwave radiation ( $\sim 340 \text{ W m}^{-2}$ ) (L'Ecuyer et al. 2015). The Clouds and the Earth's Radiant Energy System (CERES) project has been measuring the Earth radiative budget at TOA for several decades now (Loeb et al. 2018). The measurements are difficult, involving the incoming solar radiation, the scanning of outgoing radiation both visible and infrared, cloud cover, aerosols, and instrumental problems. The precision of the measurement is evaluated at the order of  $0.17 \text{ W m}^{-2}$  (90% confidence level) at interannual time scales but because of a potential bias of about  $\pm 2 \text{ W m}^{-2}$ , the accuracy is above  $\pm 2 \text{ W m}^{-2}$ . The precision of CERES is sufficient to evaluate small changes in time of the EEI that are induced by natural or anthropogenic forcing (Loeb and Doelling 2020; Raghuraman et al. 2021). But the accuracy is not sufficient to estimate the mean EEI generated over the past decades by anthropogenic greenhouse gases emissions.

Another approach to estimate the EEI consists in estimating the excess of energy that is stored in the climate system in response to the TOA radiative imbalance. With its high thermal inertia and its large volume, the ocean accumulates, in the form of heat, more than 90 % of the excess of energy that is stored by the climate system (von Schuckmann et al. 2020). The other climate reservoirs (i.e., atmosphere, land, and cryosphere) play a minor role



in the energy storage at seasonal and longer timescales (von Schuckmann et al. 2020). As a result, the ocean heat uptake (OHU) is a precise proxy of the EEI and estimating the OHU is an efficient approach to estimate the EEI.

The OHU can be estimated with an accuracy of a few tenths of  $W m^{-2}$  and thus provides an approach to estimate the mean EEI generated over the past decades by anthropogenic greenhouse gases emissions. This is possible with 2 approaches: (1) from direct in situ measurements of temperature–salinity profiles mainly derived from the Argo float network; (2) from the thermal expansion of the ocean derived from a space geodetic approach (Meyssignac et al. 2019). These methods are complementary, with their own advantages and limitations. The direct measurement approach relies on in situ measurements from Argo which are unevenly spatially distributed with poor sampling of the deep ocean (below 2000 m depth), marginal seas, and below seasonal sea ice. The space geodetic approach measures the sea level changes due to the thermal expansion and saline contraction of the ocean (also called steric sea level changes) derived from the differences between the total sea level change derived from satellite altimetry measurements and the barostatic sea level changes from satellite gravity measurements. This approach offers consistent spatial and temporal sampling of the ocean through time, with a nearly global coverage of the oceans, except for the polar regions (above  $82^\circ$ ). It also provides OHU estimates from the entire ocean water column. But it does not provide the vertical structure of the OHU unlike the Argo approach. It is crucial to develop both the geodetic approach and the in situ approach to derive EEI estimates that are cross validated and thus reliable.

The EEI shows time variations in response to anthropogenic emissions and natural variability like ocean–atmosphere interactions or volcanic eruptions. The coupled natural variability of the ocean and of the atmosphere leads to monthly to interannual variations of the order of a few  $W m^{-2}$  (Loeb et al. 2018). Decadal and longer-term variations of the order of a few tenths of  $W m^{-2}$  are associated with the anthropogenic and the natural forcing of the climate system (Loeb and Doelling 2020). On decadal time scales the EEI shows trends of the order of a few cents of  $W m^{-2} year^{-1}$  in response to changes in the external forcing either natural or anthropogenic (Loeb and Doelling 2020; Raghuraman et al. 2021). To evaluate these variations and particularly the small decadal and longer-term response of EEI to anthropogenic or natural forcing, EEI should be estimated with an accuracy better than  $\pm 0.1 W m^{-2}$  and a stability better than  $\pm 0.02 W m^{-2}/year$ . This is particularly challenging, and it requires a fine characterization of the errors associated with the EEI estimates. In the case of the EEI

derived from the geodetic approach the limiting factors at decadal time scales come from the uncertainty in the GIA correction and in the ITRF realization (see Blazquez et al. 2018; Meyssignac et al. 2019). In particular, the uncertainty on the Z motion of the geocenter of the ITRF which affects both the satellite altimetry estimate of the sea level changes at mid to high latitudes and the gravimetry estimate of the ocean mass changes is a primary source of uncertainty on the EEI at decadal and longer time scales (see Marti et al. 2022; Blazquez et al. 2018) (see also Guérou et al. in preparation).

To reach an accuracy of  $\pm 0.1 W m^{-2}$  and a stability of  $\pm 0.02 W m^{-2}/year$  in EEI on decadal time scales an accuracy of  $\pm 0.25 mm$  and a stability of  $\pm 0.05 mm/year$  is necessary on sea level and ocean mass rates estimates at decadal time scales. This is achievable only with more accurate and more stable reference frame realizations, which is the primary goal of the GENESIS mission.

#### **Ionospheric and plasmaspheric density**

The Earth's ionosphere is defined as the atmospheric layer, typically between 80 km and 1000 km altitude, where the electron density is sufficient to significantly influence the propagation of electromagnetic waves that travel into it (Davies 1990). Its main effect is the modification of the wave propagation velocity, which is proportional to the integrated electron density along the wave propagation direction, called total electron content (TEC). Secondary effects are a modification of the wave amplitude and a bending of the propagation vector, with respect to the generally assumed straight line.

The electron density profile is characterized by a Chapman-profile shape, with a peak at an altitude typically ranging from 200 km to 350 km. At mid- and low-latitudes, above the ionosphere is the plasmasphere, constituting a reservoir of cold particles (mainly electrons, protons and helium ions) that fills during the day and drains at night (Russel et al. 2016). Its location, as well as the particle motion, is controlled by the geomagnetic field whose dipolar nature confines the plasma. The main control of these ionized mediums is the solar activity that drives extreme ultraviolet radiation (hence the primary source for ionization) and that modifies the solar wind which constantly interacts with the geomagnetic field. Besides this variability “from above” many irregularities arise “from below”, i.e., for which the origin is located in the lower atmospheric layers or at the ground level (Fuller-Rowell et al. 2017). One of the most important ionospheric variability sources lies in the equatorial region and is known as the “fountain effect”: a rapid change in the neutral wind creates an important  $\vec{E} \times \vec{B}$  (where  $\vec{E}$  is the electric field and  $\vec{B}$  the magnetic field) vertical drift that lifts the plasma up to 1000 km altitude

(Kelley 2009). The plasma plumes are then redistributed on the either side of the magnetic equator to form the so-called “ionization anomaly crests”, being two regions of local maximum electron density. To that are associated small-scale irregularities called equatorial plasma bubbles, which appear during post-sunset hours at low-latitudes and produce plasma depletions that disturb radio communications and GNSS services (Kintner et al. 2007). More precisely, they are responsible for signal scattering that fades out the signal amplitude, leading to fluctuating signal-to-noise ratio that prevents optimal GNSS satellite tracking, or even worst, interrupts it.

During the last two decades, an important number of GNSS receivers has been included on board LEO satellites orbiting at various altitudes, besides an extensive network of ground-based receivers. They continuously receive the signal broadcasted by GNSS satellites offering an excellent time and space coverage and allowing to reliably monitor the TEC above a given LEO satellite (Wautelet et al. 2017). In the latter methodology, the retrieved TEC is the by-product of the differential code biases computation performed using only LEO-based observation (i.e., no ground station) to minimize the impact of the ionospheric peak in the differential code biases adjustment. Depending on the orbit altitude and the geomagnetic latitude, the TEC above the spacecraft would mostly express the ionization crests or the plasmaspheric contribution.

In the framework of a circular orbit at an altitude of 6000 km, as planned for the GENESIS mission (see section [CDF study output](#)), the plasmaspheric TEC would be very small, and even negligible. The LEO-DCB (differential code biases) computation software should be able to quantify this contribution and provide, if plasmaspheric TEC contribution is actually negligible, accurate and reliable DCB values for GNSS satellites and onboard receiver.

In addition to the zenith GNSS antenna, a nadir-pointing GNSS antenna would enable the observation of radio-occultation profiles of GNSS satellites, as the same manner as for dedicated missions COSMIC and COSMIC-2. Using appropriate inversion methods on such observations will provide additional electron density profiles that will benefit the ionosphere/plasmasphere community. Moreover, the high inclination of the GENESIS orbit will provide occultations above polar and sub-polar regions, which are not geographically covered by the dedicated missions COSMIC and COSMIC-2. By providing electron density profiles at polar regions, GENESIS will improve the observability and the understanding of the dynamics in this region where the ionosphere meets the solar environment.

## Benefits for navigation sciences and metrology

### Improvement in global positioning

The positioning of stations in a GNSS network relies on global solutions of complete satellite constellations and on the simultaneous adjustment of station coordinates. These solutions involve a large number of parameters that will degrade the observability of the station coordinates, and may also introduce biases in the solutions: tropospheric propagation models, empirical solar radiation pressure parameters of the satellites, antenna characteristics such as PCO, phase variations (PV), which may or may not be adjusted.

In a global GNSS solution, the clock biases of the transmitters and receivers must be managed. Regardless of the strategy used (estimation or differentiation), the resulting information for the geometry is the same. The result is a significant reduction in the observability of the Earth's center of mass, i.e., the origin of the reference frame (Rebischung et al. 2014; Meindl et al. 2013). This includes the motion of the geocenter whose north–south motion is not well observed by GNSS constellations and is corrupted by draconitic signals from orbit solutions (see section [Improvements in the ITRF geocenter and scale](#)).

Some improvements could be achieved if the GENESIS onboard oscillator can be modeled with sufficient accuracy over long periods (typically one day), allowing a drastic reduction in the impact of receiver-related clock parameters. A comparison of the onboard USO to ground atomic clocks could be achieved thanks to an A-LRR (see section [Passive and active laser retro-reflector](#)). For example, a model of the USO on board Jason-2 satellite was developed thanks to the Time Transfer by Laser Link (T2L2) instrument (Belli et al. 2016).

The frame scale factor is also directly connected to the transmitters' and receivers' PCO/PV characteristics. For the ground receivers, independent calibration methods are used by the International GNSS Service. For the transmitters, only Galileo provides calibrations performed on ground before launch. It has been shown that this has an important impact on the observed scale factor. The GENESIS satellite, carrying a GNSS receiver, can provide a lot of information about the scale and the motion of the geocenter (see section [Improvements in the ITRF geocenter and scale](#) for more details). Therefore, careful design of the GENESIS platform is required to minimize the sensitivity of the dynamic modeling to external effects such as direct and reflected solar radiation pressure. For the measurement of long-term variations of these accelerations, the currently used accelerometer technology, which requires a posteriori calibration, is not suitable.

Contributions to the performance of GNSS by GENESIS will include the following:

- 1 The well-calibrated satellite platform will provide local tie vectors in space between physical antenna phase centers allowing for a high-precision linking of GNSS observations with the other space geodetic techniques, referencing GNSS positioning results to a well-defined reference frame (see section [Importance of reference frames](#) and section [Present status of the terrestrial reference frame realization](#)).
- 2 The satellite antenna provides a clean absolute reference for accurate and consistent calibration of the transmitting antennas of all GNSS satellites, without atmospheric propagation errors. In the case of Galileo, the antenna phase maps measured on the ground will allow a better validation of these calibrations (see section [GNSS antenna phase center calibration](#)). Pseudo-range biases will also be observed with much better accuracy due to the reduction of ionospheric pseudo-range errors (see section [Ionospheric and plasmaspheric density](#)).
- 3 The specific observability in the radial direction of the satellite orbit allows GNSS to independently contribute to the realization of the scale and origin of the Earth reference frame (see section [Improvements in the ITRF geocenter and scale](#)).

As a proof of concept the capability of calibrating Global Positioning System (GPS) transmit antennas using receivers on board LEO satellites without relying on an external scale was demonstrated by Haines et al. (2015) using GPS tracking data from GRACE-B and TOPEX/Poseidon.

#### GNSS antenna phase center calibration

Conventionally a mechanical reference point is defined for each GNSS antenna while the actual transmitting or receiving point might differ by up to few centimeters. For the receiving antenna these PCOs and direction-dependent phase variations have been discussed since the early 1990s leading to sophisticated calibration methods (Rothacher et al. 1995; Elosegui et al. 1995; Mader 1999; Wübbena et al. 2000). Compared deviations for the GNSS satellites became apparent with the evolution of the GPS constellation in the early 2000s (Zhu et al. 2003; Ge et al. 2005; Cardellach et al. 2007). The problem was partially solved by estimating the GNSS transmitter antenna patterns in the adjustment process (Schmid and Rothacher 2003; Bar-Sever 1998; Schmid et al. 2005; Dilßner 2010; Steigenberger et al. 2016). This approach suffers from considerable limitations. The major restriction is the correlation between the terrestrial scale, the satellite clock, and the satellite antenna offsets resulting from the observation geometry. As one consequence, the scale information is transferred from VLBI and SLR networks to the GNSS network (Schmid et al. 2007) which

prevents GNSS from providing an independent scale. The second limit is given by the fact that the absolute antenna phase patterns of ground tracking sites are contaminated by local environmental effects such as time-variable multipath. A third limitation is given by the required estimation of tropospheric delays for each ground station. In 2016, Galileo released precise calibrations for antenna phase center and phase variations. Applying them in the GNSS estimation, differences between GPS- and Galileo-based coordinates become visible (Villiger et al. 2018). By fixing the Galileo PCOs to the calibrated values, a Galileo-based scale is realized and the GPS PCOs were estimated simultaneously in an integrated processing (Villiger et al. 2020).

A totally independent method to estimate scale-free GNSS PCOs is given via the usage of space-based GNSS observations and the gravitational constraints from the orbital dynamics of the corresponding low Earth orbiter (Huang et al. 2022). The high consistency between the LEO-based and the Galileo-based approaches has been shown by Huang et al. (2021). Despite the larger constellation of Galileo than that of LEOs (24 versus 10+ in 2022), the LEO-based approach has advantages in several important aspects. The additional geometry due to the fast movement and the altitudes of the LEOs both benefit the de-correlation of the GPS PCOs and the scale. The altitudes of the LEOs also lead to negligible impact of troposphere delay on the space-based observations. Moreover, the long-term available data of historical and operating LEOs can be used for the estimation of the GPS PCOs backwards in time. Recent studies by Glaser et al. (2020) and Huang et al. (2022) confirmed a one-millimeter accuracy requirement for the receiver PCO position on board the LEOs.

As the antennas of GENESIS will be fully calibrated together with the entire satellite structure, this mission offers a pure absolute reference for a precise and consistent calibration of the transmit antennas of all GNSS satellites, including Galileo and BeiDou. The orbiting geodetic observatory thus offers the possibility to determine consistent GNSS transmit phase patterns without relying on a scale from external sources, thus providing GNSS with the capability to contribute independently to the realization of the scale of the terrestrial reference frame (Bar-Sever et al. 2009; Haines et al. 2015; Huang et al. 2022). Additionally, the geometry between GENESIS and a GNSS satellite allows scanning the transmitting antenna pattern within a short time and up to nadir angles of 30°. Thus, it is possible to reduce additional correlations between the phase center offsets and the spacecraft orientation. The extension of nadir angles to 30° for transmitting antenna calibrations leads to a significant improvement in the GNSS-based orbit determination for

other scientific Earth observation missions. Therefore, GENESIS will allow improving products of such missions, especially, orbit dependent altimeter data.

#### **Positioning of satellites and space probes**

GENESIS will provide a breakthrough in space geodesy and by this will contribute to improving the accuracy of many satellite orbits, and consequently, the accuracy of the parameters that these satellites observe. POD is an integral part of analyzing the data of numerous Earth science missions and of inter-planetary space probes. Prominent examples of past, present and future missions devoted to Earth observation are radar altimetry missions such as TOPEX/Poseidon, Jason-1, -2, -3, Sentinel-3, and Sentinel-6A, laser altimetry missions such as ICESat-1 and -2, gravity missions such as CHAMP, GRACE, GOCE, and GRACE-FO, and many other missions such as the SAR/InSAR missions TerraSAR-X, TanDEM-X, and Sentinel-1, the magnetic field mission Swarm or further satellites of the Copernicus Earth observation program of the European Union.

All above mentioned missions significantly rely on POD, some of them even critically, as the quality of the science products may directly depend on the accuracy of the orbit determination, e.g., requiring a radial orbit accuracy of 15 mm with a goal of 10 mm for the science products of Sentinel-6A (Donlon et al. 2021) or a 3-D orbit accuracy of 5 cm for the Sentinel-1 mission (GMES Sentinel-1 Team 2004). This holds for all gravity missions and in particular for altimetry missions, where the radial component is of primary interest (Cerri et al. 2010). Sea level measurements from radar altimetry, e.g., are directly related to this component (International Altimetry Team 2021). For missions providing long-term climatological data records, it is therefore essential to perform the most accurate POD in a reference frame which is consistent across many years for the data analysis of many different spacecraft. In addition to a stable reference frame, which is crucial to not contaminate sea level rise measurements with reference frame drifts (Altamimi and Collilieux 2013), the highly accurate modeling of non-gravitational (e.g., Flohrer et al. 2011; Mao et al. 2021) and gravitational forces, e.g., the proper modeling of temporal gravity variations across many years (Couhert et al. 2015; Peter et al. 2022), as well as a full exploitation of multiple tracking techniques (Luthcke et al. 2003; Choi et al. 2004) is mandatory for the most accurate POD.

Similar to the orbit determination of the GENESIS spacecraft, POD of any other Earth science spacecraft refers to the positioning of the satellite CoM in a TRF. POD thereby occurs across a range of timescales: near-real-time, intermediate latency, and longer latency for mission science products and climate data records.

Missions with stringent accuracy requirements on POD usually employ multiple and independent POD payloads for this purpose. Onboard GNSS receivers, DORIS receivers, and SLR reflectors are used to improve the quality and robustness of the orbit determination and to enable cross calibrations (e.g., Montenbruck et al. 2021).

Usually GNSS data provide one of the strongest POD contributions due to the almost continuous tracking of all-in-view GNSS satellites. As the quality of GNSS-based POD critically depends on a proper modeling of systematic errors, e.g., phase center variations of the GNSS receiver and transmitter antennas (see Jäggi et al. 2009; Schmid et al. 2016, section [GNSS antenna phase center calibration](#)), the improved calibrations of the GNSS transmitter antennas, that will be provided by GENESIS, will further improve the performance of GNSS-based POD. This is of particular relevance for GNSS measurements collected at low elevation angles (or large nadir angles as seen from the GNSS), where altimetry missions collect a large amount of data and where GNSS transmitter calibrations are still poorly determined today (Schmid et al. 2016). The further reduction of systematic errors will pave the way towards mm-accurate GNSS orbit determination of Earth science spacecraft, when exploiting the integer nature of GNSS carrier phase ambiguities (Jäggi et al. 2007; Bertiger et al. 2010; Montenbruck et al. 2018).

GENESIS will also benefit the DORIS, SLR and VLBI techniques. For DORIS, the limiting error source at present is the USO sensitivity to radiation-induced perturbations, particularly while traversing the South Atlantic Anomaly (Štěpánek et al. 2020). The possibility to synchronize the USO to atomic clocks on the ground thanks to an A-LRR on board the GENESIS satellite would remove this source of error from the satellite segment. For SLR, the data from the Jason-2/T2L2 experiment made it possible for the first time to globally calibrate the time biases in the stations of the SLR network (Exertier et al. 2017). The time-transfer experiment incorporated onto the GENESIS mission would be crucial to continue such a global calibration and will thus benefit global geodesy, and indirectly POD by helping to improve the SLR technique. Finally, the VLBI transmitter (VT, see section [VLBI transmitter](#)) on board GENESIS will provide the spacecraft position in the CRF.

The GENESIS spacecraft will provide an additional platform to isolate residual biases in the ranging systems of SLR stations (e.g., Luceri et al. 2019). These residual range errors are extremely challenging to isolate, because they are dependent on ranging equipment and technique, the retro-reflector target response, the data sampling and editing when creating the SLR normal points. GENESIS will provide a platform in a MEO where the other



tracking data (GNSS, DORIS, VLBI) will help to isolate residual bias effects (e.g., Arnold et al. 2019).

Provided that the locations of the spacecraft CoM and of the individual POD sensors are all known in the respective satellite body-fixed frame with sufficient accuracy from pre-launch assessments, it will, therefore, be possible to translate the high precision of the GNSS, DORIS, and SLR data collected by Earth science spacecraft into mm-accurate satellite positions expressed in the highly accurate and long-term stable reference frame provided by GENESIS.

### Relativistic geodesy and time and frequency transfer

The International Astronomical Union recommended to introduce the General Theory of Relativity as the theoretical background for the definition of space–time reference systems (Soffel et al. 2003). Applying the General Theory of Relativity is indispensable to meet the required geodetic accuracy and stability of a TRF—i.e., 1 mm for positions and 0.1 mm/year for velocities—for detecting smallest variations in the Earth system components. GENESIS will prove the consistent use of the General theory of Relativity in space geodesy and the involved reference systems at an unprecedented accuracy level.

The direct integration of gravimetric and geometric reference frames is an open issue, where time and frequency measurements will play a central role. For the realization of a dynamical reference such as a physical height system and the related equipotential surface, called the geoid, gravity field measurements are required. Today, such an equipotential surface is only known at the centimeter to decimeter level if comparing point values on larger scales. To overcome this shortcoming, highly precise optical clocks connected by dedicated ground or space links can be used. This novel technique has reached an accuracy that allows the precise measurement of differences of the gravity potential exploiting the gravitational redshift (Müller et al. 2018; Delva et al. 2019). Optical frequency standards at the leading national metrology institutes today show relative frequency inaccuracies in the  $10^{-18}$  range (corresponding to 1 cm in height) and beyond (Brewer et al. 2019; Bothwell et al. 2019; Beloy et al. 2021). Long-distance optical frequency transfer using phase-stabilized optical fibers has been demonstrated with a relative frequency inaccuracy at the  $10^{-19}$  level (Lisdat et al. 2016), and even  $10^{-21}$  on shorter distances (Xu et al. 2019). Free-space laser links already realized common view time transfer over thousands of kilometers at the picosecond level (e.g., with T2L2, see Exertier et al. 2017), and reach on shorter distances the femto-second level for time transfer (Sinclair et al. 2019) and  $10^{-21}$  level for frequency transfer (Gozzard et al. 2022).

It is thus possible, with optical standards and frequency transfer techniques, to consistently unify height systems and to improve the accuracy of physical height reference frames and the geoid, to the cm level or better that is of prime interest in the context of GGOS and, especially, for monitoring sea level change. GENESIS could enable a proof of principle for comparing physical heights (derived from time and frequency differences) over large distances if an A-LRR will be present on board the satellite.

## Mission design and instruments

### CDF study output

Using well-established ESA CDF assessment, the GENESIS Mission feasibility has been assessed during March/April 2022, with the contribution of over 50 ESA experts covering all necessary mission feasibility expertise profiles.

The GENESIS high-level Mission Objectives have been defined as follows:

- Obj-1: Improve ITRF accuracy and stability by providing in-orbit co-location and necessary combined processing of the four space geodetic techniques that contribute to its realization, namely GNSS, SLR, DORIS and VLBI, on a highly calibrated and stable platform. The goal is to contribute to the achievement of the GGOS objectives for the ITRF realization, aiming for a parameter accuracy of 1 mm and a stability of 0.1 mm/year to the GGOS, in order to provide significant scientific benefits in Earth modeling.
- Obj-2: To improve, compared to the current state-of-the-art, the operational time and frequency transfer and synchronization globally. Target performance 10 ps in time transfer and  $10^{-18}$  for relative frequency transfer.

Thanks to the onboard VLBI, which is the only geodetic technique allowing access to the ICRF, GENESIS shall also allow obtaining a direct link between the ITRF and the ICRF (differencing the radio signal emitted by GENESIS with the signals from the fixed quasar radio sources).

The CDF study identified initial high-level mission requirements, given in Table 3. From these, the following key technical drivers are identified:

- (1) The need of a very precise onboard metrology (calibrated ties): the offset between each payload and the satellite CoM shall be known with accuracies < 1 mm. Offset stability shall remain within 1 mm-level during the whole duration of the mis-

- sion (requiring adequate thermoelastic materials; extremely accurate on-ground calibration tests; etc.).
- (2) A common time reference for all onboard instruments shall be ensured (all geodetic instruments shall be referenced and synchronized to each other).
- (3) Highly accurate precise orbit determination: GENESIS shall be able to determine the orbit with accuracies at mm level ( $< 1$  cm) (excellent GNSS POD, requiring high success rate integer ambiguity resolution and a very accurate radiation pressure model of the GENESIS satellite).
- (4) Simultaneous operation of geodetic techniques, guaranteeing the maximum contemporary use of the 4 onboard geodetic techniques (and at least 2 at all times) with best possible performances.
- As a result of the different optimizations performed at the CDF, it has been concluded that a suitable compromise in terms of POD and contribution of each technique results to be a 6000 km circular orbit with quasi-polar

**Table 3** First estimation of high-level mission requirements for GENESIS

Req. ID	Statement
001	The GENESIS mission shall be designed to achieve the main mission objective Obj-1, through the co-location in space of the following 4 geodetic techniques: GNSS, VLBI, SLR, DORIS
002	The GENESIS mission should be designed to achieve the main mission objective Obj-2, for operational time and frequency transfer and synchronization
003	The mission shall comply with the space debris mitigation regulations
004	The casualty risk for the mission shall not exceed 1 in 10000 for any re-entry event (controlled or uncontrolled). If the predicted casualty risk for an uncontrolled re-entry exceeds this value, an uncontrolled re-entry is not allowed and a targeted controlled re-entry shall be performed in order not to exceed a risk level of 1 in 10000
005	The mission shall comply with the space debris mitigation requirements in the nominal and also in the failure case
006	The mission operational lifetime shall be at least 3 years, as a minimum, excluding LEOP, commissioning and disposal
007	The GENESIS mission should be designed for a development time of 3 to 4 years
008	The GENESIS mission should target a launch date in 2027
009	Use of high-technical readiness level, demonstrated instruments and payloads shall be preferred, whenever possible
010	Maximum re-use of existing facilities at ESA and ESA Member States
011	The satellite should be launched into an orbit capable to fulfill the mission and payload requirements
012	A small satellite platform should be targeted
013	The satellite platform shall be able to accommodate all the GENESIS payloads associated to the geodetic techniques. Additionally, the platform should host the other enabling subsystems, as needed (and optional payloads as appropriate)
014	The platform nominal lifetime shall be at least 4 years
015	The offset between each payload and the satellite CoM shall be known with accuracy of 1 mm. Offset stability shall remain within 1 mm level during the whole duration of the mission
016	The CoM position should be known with 1 mm accuracy in the satellite reference frame
017	The satellite shall have a Nadir-pointing face for the whole mission duration, with a pointing accuracy less than 1 degree and a pointing stability of 0.1 degree along the whole orbit
018	The satellite platform shall be able to operate at the least 2 geodetic techniques in parallel at all times
019	Attitude determination shall be maintained at all times with accuracy below 0.1 degree
020	The POD will have to be able to determine the orbit with an accuracy better than 1 cm. POD is also affected by optical and thermal material properties (absorption, reflection and such) of the satellite outer surfaces to make an accurate radiation pressure model of the satellite. This has to be taken into account in CDF in particular with respect to impact on costs
021	The S/C shall be able to download a volume of science data as follows: GNSS tracking data (1 Hz) 0.2 GB/day; DORIS tracking data (0.1 Hz) 0.04 GB/day; Active SLR (SLR related, for synchronization between a ground clock linked to a laser station and a clock on board the satellite) 0.05 GB/day; accelerometer 0.002 GB/day
022	To provide the link with current ITRF realizations, the selected orbit shall be accessible by the established global tracking networks of the different techniques
023	VLBI shall be visible for 20 % time from at the least 2 VLBI stations separated by 10000 km
024	The GENESIS Payloads are: GNSS receiver, VLBI transmitter, a DORIS Receiver and a SLR retro-reflector
025	A common time reference for all onboard instruments
026	An accelerometer for measuring the non-gravitational accelerations, contributing to POD should be included

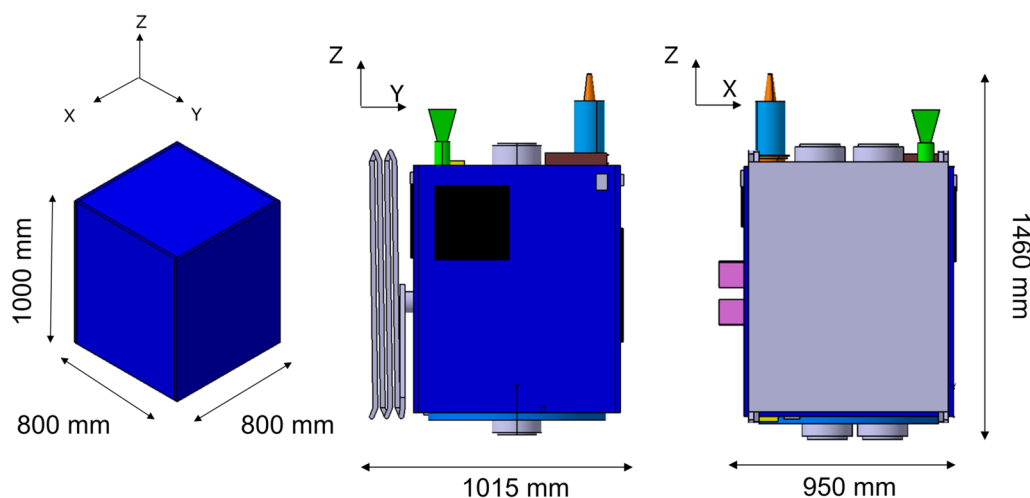

**Fig. 5** Satellite dimensions

inclination. This is selected as baseline orbit for GENESIS (requirement 011 from Table 3).

The adoption of the circular orbit is compatible with requirement 018 from Table 3 and enables also the contemporary use of the 4 geodetic techniques at the same time and long baseline VLBI observations (with more than 6500 km) over 75 % of the time.

To reach this orbit two concepts have been conceived, within the program boundaries:

- Satellite launched with VEGA-C in a sun-synchronous orbit in a piggyback configuration and the satellite being raised to the 6000 km using electrical propulsion;
- Direct injection into 6000 km orbit using a direct dedicated launch with several potential options being considered (e.g., Rocket Factory launcher, ISAR Aer-

ospace launcher, a combined launch with Ariane 62/ Galileo).

Depending on the launch option two different solutions have been defined with resulting satellite masses (wet) around 375 kg (electrical propulsion option) and 218 kg (direct injection option).

The study has been instantiated for a generic platform, based on the PROBA-V concept, although it is concluded that several other platform options may be considered, resulting in the satellite dimensions shown in Figs. 5 and 6.

The current realization of the ITRF is based on a multi-technique approach that suitably combines different observing methods taking advantage of their peculiar strengths. In particular, the frame origin is materialized by means of SLR observations; the frame scale is based on the average contribution of SLR and

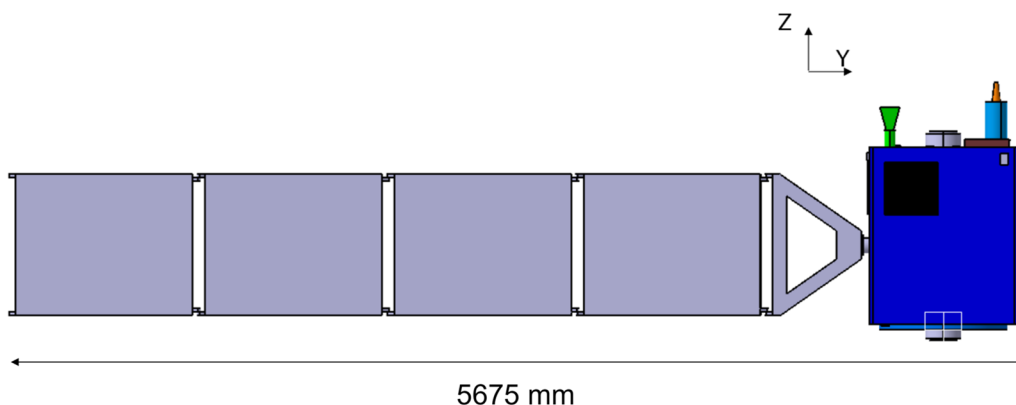

**Fig. 6** Solar panel dimensions

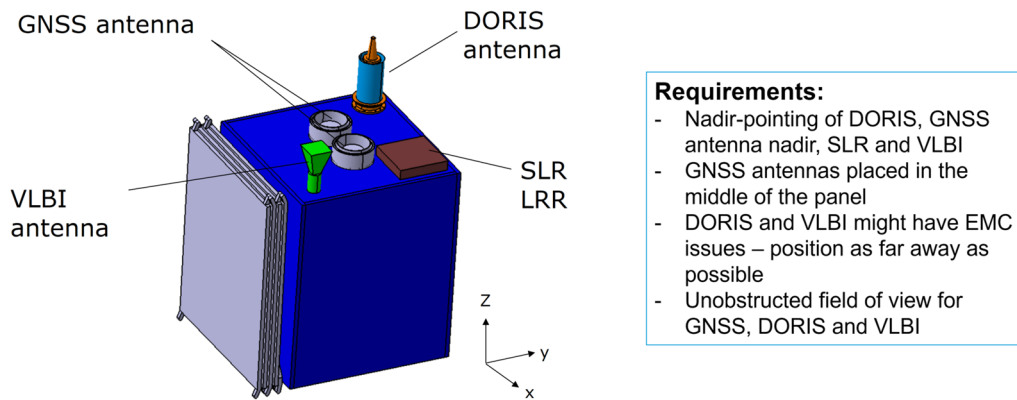

**Fig. 7** GENESIS instruments and requirements

VLBI; DORIS disseminates the frame information to radar altimetry missions; and finally GNSS participates in a large number of ground ties, contributes to establishing and maintaining the conventional frame orientation and is essential to distribute the frame to a large community of users (see section [Reference frames](#) for more details). Therefore, GENESIS will carry on board the payloads of all these space geodetic techniques, exploiting their co-location on a highly calibrated platform to further improve the ITRF accuracy and stability. The first ever co-location of VLBI with all satellite geodetic techniques will also strengthen the integration of Earth geometry and rotation.

GENESIS will be equipped with an array of passive SLR retro-reflectors (P-LRR), a VLBI transmitter, one DORIS and a GNSS receiver (baseline configuration accounts for 2 GNSS Rx in cold redundancy connected to 2 sets of antennas on the nadir and zenith faces). The DORIS instrument and GNSS Rx will require specific adaptations to fly on a 6000 km orbit. The additional installation of an active laser retro-reflector (A-LRR) device is also examined to allow accurate time transfer between SLR ground stations. At this stage, the A-LRR is considered as an optional payload, but it is considered highly desirable and easy to be integrated as part of the baseline given its reduce mass/power requirements (< 1 kg; < 1 W). All active payloads will rely on a single time standard, realized by a USO connected to a time distribution unit. An additional optional payload considered for GENESIS mission is the integration of an onboard accelerometer, to further support high-precision orbit determination, the modeling of non-conservative forces and allowing also in-orbit determination of the satellite CoM (with several existing and under evolution instruments being identified in Europe).

The design of the satellite and instruments integration is shown in Figs. 7 and 8.

In the framework of a potential international collaboration with NASA, an assessment has also been made on the possible integration of the NASA Geodetic Reference Instrument Transponder for Small Satellites (GRITTS) instrument. This instrument combines a GPS receiver and VLBI transmitter. The GRITSS concept is to upconvert the received GNSS signal and transponding it to VLBI stations (1-way biased range). This approach does not require the satellite to have a view of more than one VLBI station at a time, allowing it to be in LEO but could be adapted to MEO orbit as well. If agreed to be included, it would increase the redundancy of geodetic payloads, and would support the simultaneous testing of different approaches for satellite VLBI.

The CDF GENESIS feasibility assessment has covered all GENESIS mission technical and programmatic aspects, including: system analysis; orbit options; mission analysis; chemical propulsion; electrical propulsion; AOCS; communications; data handling; power; thermal; structures; radiation; risks and programmatic; costs.

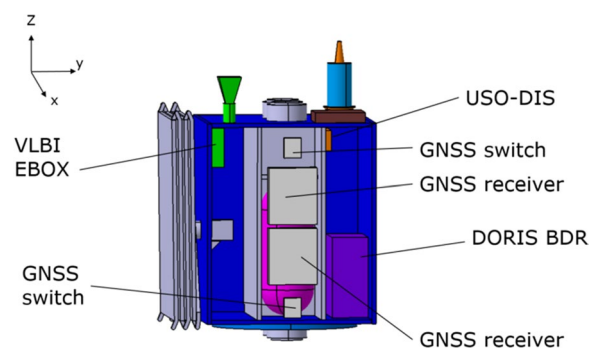

**Fig. 8** GENESIS instruments



A detailed CDF GENESIS Report is currently under conclusion. A public version of this CDF Report will also be available.

As a main result of the ESA CDF assessment, the GENESIS Mission has been confirmed to be feasible within the ESA FutureNAV defined program boundaries, with a target launch date in 2027 (assuming the program is started in Q1 2023).

#### Passive and active laser retro-reflector

The SLR observable is the round-trip time of flight of a laser pulse between a ground station and a target equipped with a laser retro-reflector. Timing and time transfer techniques are at the heart of this activity. This technique makes a fundamental contribution to the establishment of the ITRF, thanks to a network of observatories spread over a large part of the globe, the International Laser Ranging Satellite Network (Pearlman et al. 2019) [Reference frames](#). The majority of satellites tracked by the International Laser Ranging Service (ILRS) carry P-LRR. The size, the number and the arrangement of Corner Cube laser retro-reflector are a compromise between the link budget at the given satellite altitude, the orbit eccentricity and the metrological performances.

Corner Cube laser retro-reflector can be arranged spherically, e.g., in LAGEOS, LAGEOS-2 and LARES-2 (which are premiere geodetic satellites of the ILRS) or as a flat panel as for the Galileo satellites (ILRS Website 2018). Spherical arrays give the best accuracies. For example, LARES-2 (40 cm diameter,  $\sim 300$  kg mass) is a P-LRR delivered by the Italian Space Agency designed to achieve a SLR accuracy of 1 mm (compared to the 5 mm of LAGEOS) (Ciufolini et al. 2017). It was launched successfully by ESA on July 13, 2022, with the qualification flight of the Vega C and it was successfully tracked by the ILRS SLR network from July 14. Another spherical P-LRR of significantly reduced size ( $\sim 10$  cm) and mass (kg level) compared to LARES-2 has been designed to achieve a SLR accuracy of 2 mm for LEO satellites to be launched from 2024.

Alternatively, an A-LRR can synchronize ground-based atomic clocks at intercontinental distances using standard satellite laser ranging techniques. An A-LRR allows the precise determination of the onboard clock and the monitoring of its behavior in the space environment (gravity field, radiation, temperature) as a supplement to the POD provided by the conventional SLR. Such an idea has been demonstrated by SLR ground stations with the T2L2 instrument on board the Jason-2 satellite (Belli et al. 2016). This project highlighted the wide disparity between laser stations in local time management. This demonstration of time transfer by laser link is also expected for the European Laser Timing instrument of

the Atomic Clock Ensemble in Space (ACES) experiment on board the International Space Station, which should be launched in 2024 (Cacciapuoti et al. 2020).

An A-LRR on board GENESIS would allow:

- to benefit from a modern retro-reflector designed to achieve millimeter accuracy and metrologically attached to the other space geodetic instruments;
- be able to perform ground-to-space and ground-to-ground frequency and time transfers with an extended common view compared to T2L2 and ACES missions by taking advantage of the higher altitude of the satellite;
- to compare GNSS and laser time transfer techniques with an uncertainty below 100 ps;
- to be able to accurately monitor the behavior of the onboard clock for precise orbitography.

The P-LRR is typically less expensive than an A-LRR counterpart. Being completely passive, it does not use any resources on board GENESIS (except its mass and volume envelope). A combination of both a P-LRR and A-LRR would provide all combined benefits, as well as the sum of the resources and mass/volume envelopes needed on board GENESIS.

#### VLBI transmitter

Observations to distant radio sources, such as quasars, with the VLBI technique enable the determination of a space-fixed celestial reference frame like the ICRF with its current realization ICRF3 (Charlot et al. 2020) and the Earth Orientation Parameters (EOP). VLBI is the only technique that provides the full set of EOP (polar motion, UT1, celestial pole offsets), contributes to the ITRF scale, and uniquely realizes ICRF, as opposed to the satellite-based techniques (see section [Improvements in the ITRF geocenter and scale](#)). The connection of the ITRF to the ICRF through VLBI enables the study of the dynamics of the interior of the Earth through the wandering of the motion of the poles with respect to the celestial frame, as well as studying tidal dissipation and seasonal or interannual effects in the geophysical fluids on the solid Earth through measurements of the rotation rate of the Earth (see section [Unification of reference frames and Earth rotation](#)).

The fundamental VLBI measurements are signal delay observations of the incoming radio signals between pairs of tracking stations. Over time, and using multiple distant radio sources, these measurements enable the determination of the baseline vectors between pairs of stations. The orientation of these vectors in the CRF defines the Earth orientation in that frame. The lengths of these vectors, known to millimeter accuracy, critically

contribute to the determination of the scale of the ITRF (Altamimi et al. 2016). The VLBI observation campaigns and data processing are coordinated by the International VLBI Service for Geodesy and Astrometry (Nothnagel et al. 2017; IVS Website 2021).

One of the unique features of GENESIS is the VLBI transmitter (VT) that will accurately connect geodetic VLBI stations through a space-tie to the other geodetic techniques. The VT instrument will transmit signals in different frequency bands in order to eliminate the ionospheric dispersive delay along the paths to each observing VLBI station, and comply with the evolving observations procedures at all VLBI stations. The signals can be observed by all geodetic VLBI stations, including the new VLBI Global Observing System (VGOS) fast slewing stations that are coming online, in their standard geodetic receiver setups. The VT will exploit the full extent of the frequency bands allocated on a worldwide co-primary basis to the Earth exploration satellite service through the International Telecommunications Union Radio-communication Sector. The ultra-low-power density signals of the VT will be well below the applicable coordination thresholds, ensuring easy compatibility with ITU rules. Using the conventional VLBI technique of correlating received signals across baselines it will be possible not only to determine the baseline vectors, as in conventional VLBI, but also the absolute geocentric position of the receiving sites. VLBI observations of GENESIS will therefore enable these stations to be accurately located within the GENESIS TRF consistently with the other geodetic techniques, enable a frame tie between the celestial frame and the dynamic reference frames of satellite orbits as well as a frame tie between the GENESIS TRF and the extremely accurate and stable inertial celestial frame.

A European VT, compatible with the accommodation constraints on board the Galileo satellite, performance of the receiving stations as well as with the ITU regulations in all transmission frequency bands is currently under development for consideration of Galileo second generation satellites (H2020 HSNV Website 2020). The VT is currently designed to transmit at different frequencies between 2 GHz to 14 GHz, but also higher frequency bands can be considered. The present setup for regular VGOS observations use four 1-GHz-wide bands within the S, C, and X frequency bands. Discussions of including higher frequencies in Ka band is ongoing in order to maximize the covered signal bandwidth since the VLBI estimates of group delay is approximated by the reciprocal of the observed bandwidth. It may be possible to investigate linking the ICRF across frequency bands using the GENESIS satellite as a well-calibrated multi-frequency target. The VT is designed to transmit

both pseudo-noise and random noise. The random noise signal mimics the broader-band noise emitted by quasar radio sources routinely observed by VLBI, hence can be processed by essentially the usual station software. The required and projected precision of phase measurement supported by the VT are 0.1 mm and 0.01 mm, respectively, for 1 s observable.

The feasibility of a dedicated VLBI transmitter on board future Galileo satellites and the assessment of the impact of quality and quantity of satellite observations on the derived geodetic parameters were studied recently by various authors (see Jaradat et al. 2021, Klotek et al. 2020, Sert et al. 2022 and references therein). The concept of measurement and equipment choices were discussed in Jaradat et al. (2021) and the signals designed to mimic the quasars' radiation as observed and recorded by ground-based telescopes were simulated. The output signal of this chain using 2 Hz to 11 GHz for VGOS, was also tested using a VLBI baseband data simulator, then correlated and fringe-fitted for validation. It was shown that the combination of quasar and satellite observations could allow theoretically for simultaneous estimation of Earth rotation parameters (polar motion and UT1–UTC) along with geocenter offsets, VLBI station positions and satellite orbits (Klotek et al. 2020). In the case of carefully selected satellite observations and optimized scheduling with the VGOS-type network, detection of geocenter motion could be feasible. The use of VT on GNSS satellites and observation assessment including the UT1–UTC transfer quality for Galileo orbits was demonstrated in Sert et al. (2022). These recent studies confirm the significance of dedicated onboard transmitters and the potential of geodetic VLBI as another space geodetic technique.

Observations of quasars and GENESIS satellite within the same sessions will provide the geodetic community with a great opportunity for directly linking the dynamical reference frame of satellite orbits to the quasi-inertial reference frame of extragalactic radio sources and redefining the role of VLBI in space geodesy.

## Conclusion

The first objective of the GENESIS mission is to contribute to the achievement of the GGOS accuracy and stability goals concerning the ITRS realization, aiming for 1 mm and 0.1 mm/year, respectively. To this aim, GENESIS will provide in-orbit co-location of the four space geodetic techniques: GNSS, SLR, DORIS, and VLBI, on a highly calibrated and stable platform.

We have shown in this article the primary and critical importance of the International Terrestrial Reference Frame (ITRF) and associated geodetic infrastructure

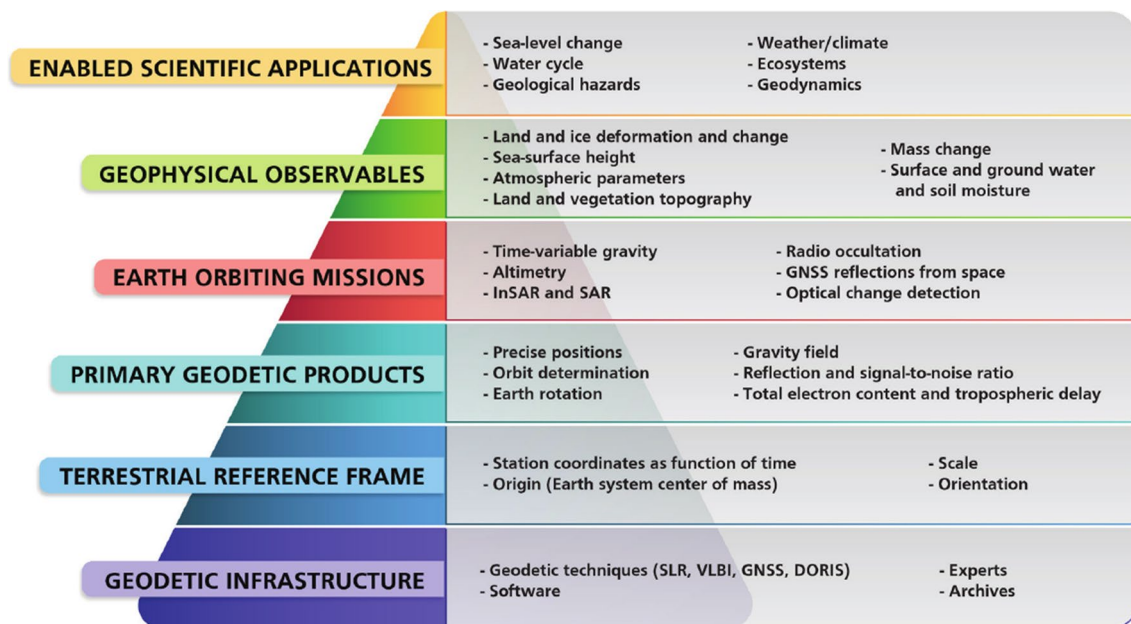

**Fig. 9** Illustration of how the geodetic infrastructure is linked to enabled scientific applications (National Academies of Sciences, Engineering, and Medicine 2020)

and products for many scientific applications in Earth and navigation sciences. This is illustrated in Fig. 9. In particular, the accuracy and stability of the ITRF is very important in the context of climate change to measure sea level rise, improve estimates of ice mass balance, and determine Earth’s energy imbalance—which are all observables that are critical in climate change studies. Moreover, the ITRF improvements can affect and improve many geodetic and geophysical observables as well as precise navigation and positioning.

In addition, the ITRF improvements strengthen the geodetic infrastructure, including the Galileo constellation, by reducing biases and errors between different techniques. GENESIS will be complementary and enhance the products of several other missions such as gravimetry and altimetry satellites. The addition of optional payloads such as an active laser retro-reflector (A-LRR) and an accelerometer can pave the way for very interesting and complementary objectives in navigation and time/frequency metrology.

The crucial necessity of an accurate and stable realization of ITRS is endorsed by a large community of scientists and industries as well as various authorities, including the IAG and the UN. Finally, a study by the CDF of ESA has demonstrated the feasibility of the GENESIS mission within the ESA FutureNAV defined program boundaries, with a targeted launch date in 2027.

**Abbreviations**

ACES	Atomic Clock Ensemble in Space
A-LRR	Active laser retro-reflector
CDF	Concurrent Design Facility
CERES	Clouds and the Earth’s Radiant Energy System
CF	Center of figure (of the Earth)
CM	Center of mass (of the Earth)
CoM	Center of mass (of the satellite)
CRF	Celestial Reference Frame
DGFI-TUM	Deutsches Geodätisches Forschungsinstitut at Technische Universität München
DORIS	Doppler Orbitography and Radiopositioning Integrated by Satellite
EI	Earth energy imbalance
EOP	Earth Orientation Parameters
ESA	European Space Agency
GGOS	Global Geodetic Observing System
GGRF	Global Geodetic Reference Frame
GIA	Glacial Isostatic Adjustment
GMSL	Global mean sea level
GNSS	Global Navigation Satellite System
GPS	Global Positioning System
GRACE	Gravity Recovery and Climate Experiment
GRACE-FO	Gravity Recovery and Climate Experiment Follow On
IAG	International Association of Geodesy
ICESat	Ice, Cloud, and land Elevation Satellite
ICESat-2	Ice, Cloud, and land Elevation Satellite 2
ICRF	International Celestial Reference Frame
ICRS	International Celestial Reference System
IERS	International Earth Rotation and Reference Systems Service
IGN	Institut national de l’information géographique et forestière
ILRS	International Laser Ranging Service
IPCC	Intergovernmental Panel on Climate Change
ITRF	International Terrestrial Reference Frame
ITRS	International Terrestrial Reference System
IUGG	International Union of Geodesy and Geophysics
JPL	Jet Propulsion Laboratory

LAGEOS	LAser GEOdynamics Satellites
LARES	LAser RElativity Satellite
LEO	Low-Earth Orbit
LLR	Lunar Laser Ranging
MEO	Medium-Earth Orbit
OHU	Ocean heat uptake
PCO	Phase Center Offsets
PV	Phase variations
P-LRR	Passive laser retro-reflector
POD	Precise orbit determination
SLR	Satellite Laser Ranging
SRP	Solar Radiation Pressure
SDGs	Sustainable Development Goals
T2L2	Time Transfer by Laser Link
TEC	Total electron content
TOA	Top Of the Atmosphere
TRF	Terrestrial Reference Frame
TRS	Terrestrial Reference System
UN	United Nations
UN-GGIM	United Nations Committee of Experts on Global Geospatial Information Management
USO	Ultra-stable oscillator
VGOS	VLBI Global Observing System
VLBI	Very Long Baseline Interferometry
VT	VLBI transmitter

### Acknowledgements

The GENESIS mission is supported by many scientists, industrial partners, and space agencies, namely: Elisa Felicitas Arias (Paris Observatory-PSL, France), François Barlier (Côte d'Azur Observatory, France), Bruno Bertrand (Royal Observatory of Belgium, Belgium), Claude Boucher (Bureau des Longitudes, France), Sara Bruni (PosiTIm UG at ESA/ESOC, Germany), Carine Bruyninx (Royal Observatory of Belgium, Belgium), Hugues Capdeville (CLS, France), Corentin Caudron (Université libre de Bruxelles, Belgium), Julien Chabé (Côte d'Azur Observatory, France), Sara Consorti (Thales Alenia Space, Italy), Christophe Craeey (Université catholique de Louvain, Belgium), Pascale Defraigne (Royal Observatory of Belgium, Belgium), Clovis De Matos (ESA/HQ, France), Jan Douša (Geodetic Observatory Pecny, Czech Republic), Fabio Dovis (Politecnico di Torino, Italy), Frank Flechtner (GFZ German Research Centre for Geosciences, Potsdam, Germany), Claudia Flohrer (BKG, Germany), Aurélien Hees (Paris Observatory-PSL/CNRS, France), René Jr. Landry (Québec University, Canada), Juliette Legrand (Royal Observatory of Belgium, Belgium), Jean-Michel Lemoine (GET/CNES/CNRS, France), David Lucchesi (IAPS/INAF, Italy), Marco Lucente (IAPS/INAF, Italy), Nijat Mammadaliyev (Technische Universität Berlin, GFZ Potsdam, Germany), Grégoire Martinot-Lagarde (Côte d'Azur Observatory, France), Stephen Merkowitz (NASA GFSC, United States), Gaetano Mileti (University of Neuchâtel, Switzerland), Terry Moore (University of Nottingham, United Kingdom), Juraj Papco (Slovak University of Technology, Slovakia), Roberto Peron (IAPS/INAF, Italy), Paul Rebischung (IGN/IPGP, France), Pascal Rosenblatt, LPG/CNRS (France), Séverine Rosat, ITES-EOST/CNRS (France), Matteo Luca Ruggiero, Università degli Studi di Torino (Italy), Alvaro Santamaria (Université Paul Sabatier, France), Francesco Santoli (IAPS/INAF, Italy), Feliciano Sapio (IAPS/INAF, Italy), Jaume Sanz (Universitat Politècnica de Catalunya, Spain), Patrick Schreiner (GFZ German Research Centre for Geosciences, Potsdam, Germany), Erik Schonenmann (ESA/ESOC, Germany), Laurent Soudarin (CLS, France), Cosimo Stallo (Thales Alenia Space, Italy), Dariusz Strugarek (Wrocław University of Environmental and Life Sciences, Poland), Angelo Tartaglia (INAF, Italy), Daniela Thaller (BKG, Germany), Maarten Vergauwen (KU Leuven, Belgium), Francesco Vespe (Agenzia Spaziale Italiana, Italy), Massimo Visco (IAPS/INAF, Italy), Jens Wickert (GFZ German Research Centre for Geosciences, Potsdam, Germany) and Paweł Wielgosz (University of Warmia and Mazury, Poland).

### Author contributions

All authors read and approved the final manuscript.

### Funding

JB and AN are grateful to the Austrian Science Fund (FWF) for supporting this work with project P33925. Work by SD has been supported by INFN and by ASI (Italian Space Agency) under the ASI-INFN Joint Lab Agreement n. 2019-15-HH.0. The contribution of JM was supported by the Deutsche

Forschungsgemeinschaft (DFG, German Research Foundation) via Collaborative Research Center CRC 1464 "TerraQ", project-ID 434617780, and Germany's Excellence Strategy EXC 2123 "QuantumFrontiers", project-ID 390837967. Work by SG has been supported by the German Research Foundation (DFG) under Grant Number SCHU 1103/8-1 (GGOS-SIM, Simulation of the Global Geodetic Observing System) and SCHU 1103/8-2 (GGOS-SIM-2). The research of VD and HS leading to some of these results has received funding from the European Research Council under ERC advanced grant 670874 (RotaNut—Rotation and Nutation of a wobbly Earth), as well as ERC synergy Grant 855677 (GRACE-FUL—Gravimetry, magnetism and core flow).

### Availability of data and materials

Not applicable.

### Declarations

#### Competing interests

The authors declare that they have no competing interests.

#### Author details

<sup>1</sup>SYRTE, Observatoire de Paris-PSL, Sorbonne Université, CNRS UMR8630, LNE, 61 avenue de l'Observatoire, 75014 Paris, France. <sup>2</sup>Université de Paris Cité, Institut de physique du globe de Paris, CNRS, IGN, 75005 Paris, France. <sup>3</sup>LEGOS, Université de Toulouse (CNES, CNRS, IRD, UPS), 14 avenue Édouard Belin, 31401 Toulouse, France. <sup>4</sup>Centre National d'Études Spatiales (CNES), 18 avenue Édouard Belin, 31401 Toulouse, France. <sup>5</sup>DGFI, Technische Universität München, Arcisstraße 21, 80333 München, Germany. <sup>6</sup>Technische Universität Wien, Wiedner Hauptstraße 8-10, 1040 Vienna, Austria. <sup>7</sup>Institut Terre & Environnement de Strasbourg, Université de Strasbourg, CNRS UMR7063, 5 rue René Descartes, 67084 Strasbourg, France. <sup>8</sup>GET, Université de Toulouse (CNES, CNRS, IRD, UPS), 14 avenue Édouard Belin, 31401 Toulouse, France. <sup>9</sup>Institute of Geodesy and Geoinformatics, Wrocław University of Environmental and Life Sciences, Norwida 25, 50-375 Wrocław, Poland. <sup>10</sup>Université Côte d'Azur, CNRS, Observatoire de la Côte d'Azur, IRD, Géoazur, 2130 Route de l'Observatoire, 06460 Caussols, France. <sup>11</sup>Astronomical Institute of the University of Bern, Sidlerstrasse 5, 3012 Bern, Switzerland. <sup>12</sup>Royal Observatory of Belgium, Ringlaan 3, 1180 Brussels, Belgium. <sup>13</sup>National Institute for Nuclear Physics – Frascati National Labs (INFN-LNF), via E. Fermi 54, Frascati (Rome) 00044, Italy. <sup>14</sup>Chalmers University of Technology, Onsala Space Observatory, SE 439 92 Onsala, Sweden. <sup>15</sup>European Space Operations Center, ESA/ESOC, 64293 Darmstadt, Germany. <sup>16</sup>German Research Centre for Geosciences (GFZ), Telegrafenberg, 14473 Potsdam, Germany. <sup>17</sup>Institut für Astronomische und Physikalische Geodäsie (IAPG), Technische Universität München, Arcisstraße 21, 80333 München, Germany. <sup>18</sup>Geodesy & Geophysics Laboratory, NASA Goddard Space Flight Center, Greenbelt, MD 20771, USA. <sup>19</sup>Leibniz University Hannover, Institute of Geodesy, Schneiderberg 50, 30167 Hannover, Germany. <sup>20</sup>ITC Faculty of Geo-information Science and Earth Observation, Department of Water Resources (WRS), Hengelosestraat 99, 7514 AE Enschede, The Netherlands. <sup>21</sup>Institute of Geodesy and Photogrammetry, ETH Zurich, Stefano-Francini-Platz 5, 8093 Zurich, Switzerland. <sup>22</sup>HE Space Operations B.V. for ESA – European Space Agency, 2200 AG Noordwijk, The Netherlands. <sup>23</sup>ESA Toulouse, Centre Spatial de Toulouse, 18 Avenue Edouard Belin, 31401 Toulouse Cedex 9, France. <sup>24</sup>Laboratory of Planetary and Atmospheric Physics (LPAP), University of Liège, Allée du Six Août, 19C, 4000 Liège, Belgium.

Received: 3 October 2022 Accepted: 13 December 2022

Published online: 11 January 2023

### References

- Abbondanza C, Chin TM, Gross RS, Hefflin MB, Parker JW, Soja BS, van Dam T, Wu X (2017) JTRF2014, the JPL Kalman filter and smoother realization of the International Terrestrial Reference System. *J Geophys Res Solid Earth* 122(10):8474–8510. <https://doi.org/10.1002/2017JB014360>
- Ablain M, Meyssignac B, Zawadzki L, Jugier R, Ribes A, Spada G, Benveniste J, Cazenave A, Picot N (2019) Uncertainty in satellite estimates of global mean sea-level changes, trend and acceleration. *Earth Syst Sci Data* 11(3):1189–1202. <https://doi.org/10.5194/essd-11-1189-2019>



- Altamimi Z, Collilieux X (2013) Reference frames for applications in geosciences. Springer, Berlin, Heidelberg. <https://doi.org/10.1007/978-3-642-32998-2>
- Altamimi Z, Rebischung P, Collilieux X, Metivier L, Chanard K (2021) ITRF2020: from data analysis to results. Paper presented at the AGU Fall Meeting 2021, New Orleans, LA, 13–17 December 2021
- Altamimi Z, Rebischung P, Métivier L, Collilieux X (2016) ITRF2014: a new release of the International Terrestrial Reference Frame modeling nonlinear station motions. *J Geophys Res Solid Earth* 121(8):6109–6131. <https://doi.org/10.1002/2016JB013098>
- Altamimi Z, Rebischung P, Collilieux X, Métivier L, Chanard K (2022) ITRF2020: An augmented reference frame refining the modeling of nonlinear station motions, submitted
- Anderson J, Beyerle G, Glaser S, Liu L, Männel B, Nilsson T, Heinkelmann R, Schuh H (2018) Simulations of VLBI observations of a geodetic satellite providing co-location in space. *J Geod* 92(9):1023–1046. <https://doi.org/10.1007/s00190-018-1115-5>
- Appleby G, Rodríguez J, Altamimi Z (2016) Assessment of the accuracy of global geodetic satellite laser ranging observations and estimated impact on ITRF scale: estimation of systematic errors in LAGEOS observations 1993–2014. *J Geod* 90(12):1371–1388. <https://doi.org/10.1007/s00190-016-0929-2>
- Argus DF, Fu Y, Landerer FW (2014) Seasonal variation in total water storage in California inferred from GPS observations of vertical land motion. *Geophys Res Lett* 41(6):1971–1980. <https://doi.org/10.1002/2014GL059570>
- Argus DF, Peltier WR, Blewitt G, Kreemer C (2021) The viscosity of the top third of the lower mantle estimated using GPS, GRACE, and relative sea level measurements of glacial isostatic adjustment. *J Geophys Res Solid Earth* 126(5):e2020JB021537. <https://doi.org/10.1029/2020JB021537>
- Arnold D, Montenbruck O, Hackel S, Sošnica K (2019) Satellite laser ranging to low Earth orbiters: orbit and network validation. *J Geod* 93(11):2315–2334. <https://doi.org/10.1007/s00190-018-1140-4>
- Bar-Sever Y (1998) Estimation of the GPS transmit phase center offset. *Eos Trans AGU* 79(45):183
- Bar-Sever YE, Haines B, Wu S, Lemoine F, Willis P (2009) Geodetic Reference Antenna in Space (GRASP): A Mission to Enhance the Terrestrial Reference Frame. Paper presented at the COSPAR Colloquium – Scientific and Fundamental Aspects of the Galileo Programme, University of Padova, Padua, Italy, 14–16 October 2009. <https://gssc.esa.int/education/galileo-science-colloquium/>
- Beckley BD, Lemoine FG, Luthcke SB, Ray RD, Zelensky NP (2007) A reassessment of global and regional mean sea level trends from TOPEX and Jason-1 altimetry based on revised reference frame and orbits. *Geophys Res Lett* 34(14):L14608. <https://doi.org/10.1029/2007GL030002>
- Belli A, Exertier P, Samain E, Courde C, Vernotte F, Jayles C, Auriol A (2016) Temperature, radiation and aging analysis of the DORIS Ultra Stable Oscillator by means of the Time Transfer by Laser Link experiment on Jason-2. *Adv Space Res* 58(12):2589–2600. <https://doi.org/10.1016/j.asr.2015.11.025>
- Beloy K, Bodine MI, Bothwell T, Brewer SM, Bromley SL, Chen J-S, Deschênes J-D, Diddams SA, Fasano RJ, Fortier TM, Hassan YS, Hume DB, Kedar D, Kennedy CJ, Khader I, Koepke A, Leibrandt DR, Leopardi H, Ludlow AD, McGrew WF, Milner WR, Newbury NR, Nicolodi D, Oelker E, Parker TE, Robinson JM, Romisch S, Schäffer SA, Sherman JA, Sinclair LC, Sonderhouse L, Swann WC, Yao J, Ye J, Zhang X, Network Boulder Atomic Clock Optical, (BACON) Collaboration (2021) Frequency ratio measurements at 18-digit accuracy using an optical clock network. *Nature* 591(7851):564–569. <https://doi.org/10.1038/s41586-021-03253-4>
- Bertiger W, Desai SD, Dorsey A, Haines BJ, Harvey N, Kuang D, Sibthorpe A, Weiss JP (2010) Sub-centimeter precision orbit determination with GPS for ocean altimetry. *Mar Geodesy* 33(sup1):363–378. <https://doi.org/10.1080/01490419.2010.487800>
- Biancale R et al. (2017) E-GRASP/Eratosthenes. Proposal for Earth Explorer Opportunity Mission EE-9 in response to the Call for Proposals for Earth Explorer Opportunity Mission EE-9, unpublished
- Blazquez A, Meyssignac B (2022) The importance of an accurate geocenter motion in the Earth's water and energy budgets estimated by gravimetry. Paper presented at the GENESIS-1 Online Workshop: Co-location of Geodetic Techniques in Space, Online, 26 April 2022. [https://genesis-1.sciencesconf.org/data/09\\_2204\\_GENESIS\\_1\\_AB\\_BM\\_geocenter\\_in\\_water\\_energy.pdf](https://genesis-1.sciencesconf.org/data/09_2204_GENESIS_1_AB_BM_geocenter_in_water_energy.pdf)
- Blazquez A, Meyssignac B, Lemoine JM, Berthier E, Ribes A, Cazenave A (2018) Exploring the uncertainty in GRACE estimates of the mass redistributions at the Earth surface: implications for the global water and sea level budgets. *Geophys J Int* 215(1):415–430. <https://doi.org/10.1093/gji/ggy293>
- Blewitt G, Altamimi Z, Davis J, Gross R, Kuo C-Y, Lemoine FG, Moore AW, Neilan RE, Plag H-P, Rothacher M, Shum CK, Sideris MG, Schöne T, Tregoning P, Zerbini S (2010) Geodetic observations and global reference frame contributions to understanding sea-level rise and variability. In Church JA, Woodworth PL, Aarup T, Wilson WS (eds) *Understanding sea-level rise and variability*, Blackwell Publishing Ltd. <https://onlinelibrary.wiley.com/doi/pdf/10.1002/9781444323276.ch9>
- Bloßfeld M, Rudenko S, Kehm A, Panafidina N, Müller H, Angermann D, Hugentobler U, Seitz M (2018) Consistent estimation of geodetic parameters from SLR satellite constellation measurements. *J Geod* 92:1003–1021. <https://doi.org/10.1007/s00190-018-1166-7>
- Bothwell T, Kedar D, Oelker E, Robinson JM, Bromley SL, Tew WL, Ye J, Kennedy CJ (2019) JILA Srl optical lattice clock with uncertainty of  $2.0 \times 10^{-18}$ . *Metrologia* 56(6):065004. <https://doi.org/10.1088/1681-7575/ab4089>
- Brewer SM, Chen J-S, Hankin AM, Clements ER, Chou CW, Wineland DJ, Hume DB, Leibrandt DR (2019)  $^{27}\text{Al}^+$  quantum-logic clock with a systematic uncertainty below  $10^{-18}$ . *Phys Rev Lett* 123:033201. <https://doi.org/10.1103/PhysRevLett.123.033201>
- Cacciapuoti L, Armano M, Much R, Sy O, Helm A, Hess MP, Kehler J, Koller S, Niedermaier T, Esnault FX, Massonnet D, Goujon D, Pittet J, Rochat P, Liu S, Schaefer W, Schwall T, Prochazka I, Schlicht A, Schreiber U, Delva P, Guerlin C, Laurent P, le Poncin-Lafitte C, Lilley M, Savalle E, Wolf P, Meynadier F, Salomon C (2020) Testing gravity with cold-atom clocks in space. *Eur Phys J D* 74(8):164. <https://doi.org/10.1140/epjd/e2020-10167-7>
- Cardellach E, Elosegui P, Davis JL (2007) Global distortion of GPS networks associated with satellite antenna model errors. *J Geophys Res Solid Earth* 112(B7):B07405. <https://doi.org/10.1029/2006JB004675>
- Cazenave A, Meyssignac B, Ablain M, Balmaseda M, Bamber J, Barletta VR, Beckley B, Benveniste J, Berthier E, Blazquez A, Boyer T, Caceres D, Chambers D, Champollion N, Chao B, Chen JL, Cheng L, Church JA, Chuter S, Cogley G, Dangendorf S, Desbruyères DG, Doll P, Domingues CM, Falk U, Famiglietti J, Fenoglio-Marc L, Galassi G, Gardner A, Groh A, Hamlington B, Hogg A, Horwath M, Humphrey V, Husson L, Ishii M, Jaeggi Jevrejeva S, Johnson GC, Kolodziejczyk Kusche J, Lambeck K, Landerer FW, Leclercq P, Legrésy B, Leuliette E, Llovel W, Longuevergne L, Loomis BD, Luthcke S, Marcos M, Marzeion B, Merchant CJ, Merrifield MA, Milne G, Mitchum GT, Mohajeani Monier, Monselesan D, Nerem Palanisamy H, Paul F, Perez B, Piecuch CG, Ponte RM, Purkey SG, Reager JT, Rietbroek R, Rignot E, Riva R, Roemmich Sorensen LS, Sasgen I, Schrama Seneviratne S, Shum CK, Spaed G, Stammer D, Van De Wal R, Velicogna I, von Schuckmann K, Wada Y, Wang J, Watson C, Wiese DN, Wijffels S, Westaway RM, Woppelmann G, Wouters B (2018) Global sea-level budget 1993-present. *Earth Syst Sci Data* 10(3):1551–1590. <https://doi.org/10.5194/essd-10-1551-2018>
- Cerri L, Berthias JP, Bertiger WI, Haines BJ, Lemoine FG, Mercier F, Ries JC, Willis P, Zelensky NP, Ziebart M (2010) Precision orbit determination standards for the Jason series of altimeter missions. *Mar Geodesy* 33(sup1):379–418. <https://doi.org/10.1080/01490419.2010.488966>
- Cerri L, Lemoine JM, Mercier F, Zelensky NP, Lemoine FG (2013) DORIS-based point mascons for the long term stability of precise orbit solutions. *Adv Space Res* 52(3):466–476. <https://doi.org/10.1016/j.asr.2013.03.023>
- Charlot P, Jacobs CS, Gordon D, Lambert S, de Witt A, Böhm J, Fey AL, Heinkelmann R, Skurikhina E, Titov O, Arias EF, Bolotin S, Bourda G, Ma C, Malkin Z, Nothnagel A, Mayer D, MacMillan DS, Nilsson T, Gaume R (2020) The third realization of the International Celestial Reference Frame by very long baseline interferometry. *Astron Astrophys* 644:A159. <https://doi.org/10.1051/0004-6361/202038368>
- Chen J, Ries JC, Tapley BD (2021) Assessment of degree-2 order-1 gravitational changes from GRACE and GRACE Follow-on, Earth rotation, satellite laser ranging, and models. *J Geod* 95(4):38. <https://doi.org/10.1007/s00190-021-01492-x>

- Cheng MK, Ries JC (2018) Monthly estimates of C20 from 5 SLR satellites based on GRACE RL05 models. GRACE Technical Note TN-07. [ftp://isdctftp.gfz-potsdam.de/grace/DOCUMENTS/TECHNICAL\\_NOTES/TN-07\\_C20\\_SLR\\_RL05.txt](ftp://isdctftp.gfz-potsdam.de/grace/DOCUMENTS/TECHNICAL_NOTES/TN-07_C20_SLR_RL05.txt) (accessed on 09 December 2022)
- Choi K-R, Ries JC, Tapley BD (2004) Jason-1 precision orbit determination by combining SLR and DORIS with GPS tracking data. *Mar Geodesy* 27(1–2):319–331. <https://doi.org/10.1080/01490410490465652>
- Ciufolini I, Paolozzi A, Pavlis EC, Sindoni G, König R, Ries JC, Matner R, Gurzadyan V, Penrose R, Rubincam D, Paris C (2017) *Eur Phys J Plus* 132(8):336. <https://doi.org/10.1140/epjp/i2017-11635-1>
- Collilieux X, Altamimi Z, Ray J, van Dam T, Wu X (2009) Effect of the satellite laser ranging network distribution on geocenter motion estimation. *J Geophys Res Solid Earth* 114(B4):B04402. <https://doi.org/10.1029/2008JB005727>
- Collilieux X, Wöppelmann G (2011) Global sea-level rise and its relation to the terrestrial reference frame. *J Geod* 85(1):9–22. <https://doi.org/10.1007/s00190-010-0412-4>
- Couhert A, Cerri L, Legeais J-F, Ablain M, Zelensky NP, Haines BJ, Lemoine FG, Bertiger WI, Desai SD, Otten M (2015) Towards the 1mm/y stability of the radial orbit error at regional scales. *Adv Space Res* 55(1):2–23. <https://doi.org/10.1016/j.asr.2014.06.041>
- Couhert A, Mercier F, Moyard J, Biancale R (2018) Systematic error mitigation in doris-derived geocenter motion. *J Geophys Res Solid Earth* 123(11):10142–10161. <https://doi.org/10.1029/2018JB015453>
- Couhert A, Bizouard C, Mercier F, Chanard K, Greff M, Exertier P (2020a) Self-consistent determination of the Earth's GM, geocenter motion and figure axis orientation. *J Geod* 94(12):113. <https://doi.org/10.1007/s00190-020-01450-z>
- Couhert A, Delong N, Ait-Lakbir H, Mercier F (2020b) GPS-based LEO orbits referenced to the Earth's center of mass. *J Geophys Res Solid Earth* 125(2):e2019JB018293. <https://doi.org/10.1029/2019JB018293>
- Davies K (1990) Ionospheric radio. Peter Peregrinus Ltd., London. <https://doi.org/10.1049/PBEW031E>
- Dehant V, Laguerre R, Requier J, Rivoldini A, Triana SA, Trinh A, Van Hoolst T, Zhu P (2017) Understanding the effects of the core on the nutation of the earth. *Geod Geodyn* 8(6):389–395. <https://doi.org/10.1016/j.geog.2017.04.005>
- Delva P, Denker H, Lion G (2019) Chronometric geodesy: methods and applications. In: Puetzfeld D, Lämmerzahl C (eds) *Relativistic geodesy. Fundamental theories of physics*, vol 196. Springer, Cham. [https://doi.org/10.1007/978-3-030-11500-5\\_2](https://doi.org/10.1007/978-3-030-11500-5_2)
- Dickey JO, Marcus SL, de Viron O (2011) Air temperature and anthropogenic forcing: insights from the solid Earth. *J Clim* 24(2):569–574. <https://doi.org/10.1175/2010JCLI3500.1>
- Dillbner F (2010) GPS IIF-1 satellite antenna phase center and attitude modeling. *Inside GNSS* 5(6):59–64
- Donlon CJ, Cullen R, Giulicchi L, Vuilleumier P, Francis CR, Kuschner M, Simpson W, Bouridah A, Caleno M, Bertoni R, Rancano J, Pourier E, Hyslop A, Mulcahy J, Knockaert R, Hunter C, Webb A, Fornari M, Vaze P, Brown S, Willis J, Desai S, Desjonqueres J-D, Scharroo R, Martin-Puig C, Leuliette E, Egido A, Smith WHF, Bonnefond P, Le Gac S, Picot N, Tavernier G (2021) The Copernicus Sentinel-6 mission: enhanced continuity of satellite sea level measurements from space. *Remote Sens Environ* 258:112395. <https://doi.org/10.1016/j.rse.2021.112395>
- Drożdżewski M, Sońnica K (2021) Tropospheric and range biases in Satellite Laser Ranging. *J Geod* 95(9):100. <https://doi.org/10.1007/s00190-021-01554-0>
- Elosegui P, Davis JL, Jaldehag RK, Johansson JM, Niell AE, Shapiro II (1995) Geodesy using the Global Positioning System: the effects of signal scattering. *J Geophys Res Solid Earth* 100(B6):9921–9934. <https://doi.org/10.1029/95JB00868>
- Exertier P, Belli A, Lemoine J (2017) Time biases in laser ranging observations: a concerning issue of space geodesy. *Adv Space Res* 60(5):948–968. <https://doi.org/10.1016/j.asr.2017.05.016>
- Feliksón D, Urban TJ, Gunter BC, Pie N, Pritchard HD, Harpold R, Schutz BE (2017) Comparison of elevation change detection methods from ICESat altimetry over the Greenland Ice Sheet. *IEEE Trans Geosci Remote Sens* 55(10):5494–5505. <http://doi.org/10.1109/TGRS.2017.2709303>
- Flohner K, Otten M, Springer T, Dow J (2011) Generating precise and homogeneous orbits for Jason-1 and Jason-2. *Adv Space Res* 48(1):152–172. <https://doi.org/10.1016/j.asr.2011.02.017>
- Fox-Kemper B, Hewitt HT, Xiao C, Aðalgeirsdóttir G, Drijfhout SS, Edwards TL, Gollidge NR, Hemer M, Kopp RE, Krinner G, Mix A, Notz D, Nowicki S, Nurhati IS, Ruiz L, Sallée J-B, Slangen ABA, Yu Y (2021) Ocean, Cryosphere and Sea Level Change. In Masson-Delmotte V, Zhai P, Pirani A, Connors SL, Péan C, Berger S, Caud N, Chen Y, Goldfarb L, Gomis MI, Huang M, Leitzell K, Lonnoy E, Matthews J. BR, Maycock TK, Waterfield T, Yelekçi O, Yu R, Zhou B, editors, *Climate Change 2021: The Physical Science Basis. Contribution of Working Group I to the Sixth Assessment Report of the Intergovernmental Panel on Climate Change*. Cambridge University Press, Cambridge, United Kingdom and New York, NY, USA, pp. 1211–1362. <https://doi.org/10.1017/9781009157896.011>
- Fritsche M, Dietrich R, Rülke A, Rothacher M, Steigenberger P (2009) Low-degree Earth deformation from reprocessed GPS observations. *GPS Solut* 14(2):165–175. <https://doi.org/10.1007/s10291-009-0130-7>
- Fu Y, Argus DF, Landerer FW (2015) GPS as an independent measurement to estimate terrestrial water storage variations in Washington and Oregon. *J Geophys Res Solid Earth* 120(1):552–566. <https://doi.org/10.1002/2014JB011415>
- Fuller-Rowell T, Yizengaw E, Doherty P, Basu S (eds) (2017) *Ionospheric space weather. Longitude dependence and lower atmosphere forcing*. American Geophysical Union and John Wiley & Sons, Hoboken, New Jersey
- Gaia Collaboration, Mignard F et al. (2018) Gaia data release 2—the celestial reference frame (gaia-cr2). *Astron Astrophys* 616:A14. <https://doi.org/10.1051/0004-6361/201832916>
- Ge M, Gendt G, Dick G, Zhang FP, Reigber C (2005) Impact of GPS satellite antenna offsets on scale changes in global network solutions. *Geophys Res Lett* 32(6):L06310. <https://doi.org/10.1029/2004GL022224>
- Glaser S, Fritsche M, Sońnica K, Rodríguez-Solano CJ, Wang K, Dach R, Hugentobler U, Rothacher M, Dietrich R (2015) A consistent combination of GNSS and SLR with minimum constraints. *J Geod* 89(12):1165–1180. <https://doi.org/10.1007/s00190-015-0842-0>
- Glaser S, Michalak G, Männel B, König R, Neumayer KH, Schuh H (2020) Reference system origin and scale realization within the future GNSS constellation “Kepler”. *J Geod* 94(12):1–13. <https://doi.org/10.1007/s00190-020-01441-0>
- GMES Sentinel-1 Team (2004) GMES Sentinel-1 System Requirements Document. Technical Report ES-RS-ESA-SY-0001. <https://www.yumpu.com/en/document/read/4635086/system-requirements-document-emits-esa>. Accessed 09 December 2022
- Gozzard D, Howard L, Dix-Matthews B, Karpathakis S, Gravestock C, Schediwy S (2022) Ultrastable free-space laser links for a global network of optical atomic clocks. *Phys Rev Lett* 128(2):020801. <https://doi.org/10.1103/PhysRevLett.128.020801>
- GSA Website (2017) Galileo Satellite Metadata. <https://www.gsc-europa.eu/support-to-developers/galileo-satellite-metadata>. Accessed 05 December 2022
- H2020 HSNV Website (2020) VLBI Transmitter for G2G. <https://h2020nav.esa.int/project/h2020-038-01>. Accessed 14 Sep 2022
- Guérou A, Meyssignac B, Prandi P, Ablain M, Ribes A, Bignalet-Cazalet F (2022) Current observed global mean sea level rise and acceleration estimated from satellite altimetry and the associated uncertainty, in preparation
- Haines BJ, Bar-Sever YE, Bertiger WI, Desai SD, Harvey N, Sibois AE, Weiss JP (2015) Realizing a terrestrial reference frame using the Global Positioning System. *J Geophys Res Solid Earth* 120(8):5911–5939. <https://doi.org/10.1002/2015JB012225>
- Hansen J, Sato M, Kharecha P, von Schuckmann K (2011) Earth's energy imbalance and implications. *Atmos Chem Phys* 11(24):13421–13449. <https://doi.org/10.5194/acp-11-13421-2011>
- Hellerschmid A, McCallum L, McCallum J, Sun J, Böhm J, Cao J (2018) Observing APOD with the AuScope VLBI array. *Sensors* 18(5):1587. <https://doi.org/10.3390/s18051587>
- Huang W, Männel B, Brack A, Schuh H (2021) Two methods to determine scale-independent GPS PCOs and GNSS-based terrestrial scale: comparison and cross-check. *GPS Solut* 25(1):4. <https://doi.org/10.1007/s10291-020-01035-5>
- Huang W, Männel B, Brack A, Ge M, Schuh H (2022) Estimation of GPS transmitter antenna phase center offsets by integrating space-based GPS observations. *Adv Space Res* 69(7):2682–2696. <https://doi.org/10.1016/j.asr.2022.01.004>

- Huss M (2013) Density assumptions for converting geodetic glacier volume change to mass change. *The Cryosphere* 7(3):877–887. <https://doi.org/10.5194/tc-7-877-2013>
- ILRS Website (2018) Galileo: Reflector information. [https://ilrs.gsfc.nasa.gov/missions/satellite\\_missions/current\\_missions/ga02\\_reflector.html](https://ilrs.gsfc.nasa.gov/missions/satellite_missions/current_missions/ga02_reflector.html). Accessed 14 Sep 2022
- International Altimetry Team (2021) Altimetry for the future: building on 25 years of progress. *Adv Space Res* 68(2):319–363. <https://doi.org/10.1016/j.asr.2021.01.022>
- IPCC Report (2021) Summary for policymakers. In Masson-Delmotte V, Zhai P, Pirani A, Connors S, Péan C, Berger S, Caud N, Chen Y, Goldfarb L, Gomis M, Huang M, Leitzell K, Lonnoy E, Matthews J, Maycock T, Waterfield T, Yelekçi O, Yu R, Zhou B, editors, *Climate Change 2021: The Physical Science Basis. Contribution of Working Group I to the Sixth Assessment Report of the Intergovernmental Panel on Climate Change*. Cambridge University Press
- ITRF Website (2022) ITRF 2020 solution. <https://itrf.ign.fr/en/solutions/ITRF2020/>. Accessed 14 Sep 2022
- IUGG Website (2022) IUGG General Assemblies. <https://iugg.org/meetings/iugg-general-assemblies/>. Accessed 09 Dec 2022
- IVS Website (2021) International VLBI Service for Geodesy & Astrometry. <https://ivscc.gsfc.nasa.gov/>. Accessed 14 Sep 2022
- Jaradat A, Jaron F, Gruber J, Nothnagel A (2021) Considerations of VLBI transmitters on Galileo satellites. *Adv Space Res* 68(3):1281–1300. <https://doi.org/10.1016/j.asr.2021.04.048>
- Jetzer et al. (2017) E-GRIP: Proposal to the call for ideas by the Swiss Space Office, unpublished
- Jiang Z, Hsu Y-J, Yuan L, Tang M, Yang X, Yang X (2022) Hydrological drought characterization based on GNSS imaging of vertical crustal deformation across the contiguous United States. *Sci Total Environ* 823:153663. <https://doi.org/10.1016/j.scitotenv.2022.153663>
- Jäggi A, Hugentobler U, Bock H, Beutler G (2007) Precise orbit determination for GRACE using undifferenced or doubly differenced GPS data. *Adv Space Res* 39(10):1612–1619. <https://doi.org/10.1016/j.asr.2007.03.012>
- Jäggi A, Dach R, Montenbruck O, Hugentobler U, Bock H, Beutler G (2009) Phase center modeling for LEO GPS receiver antennas and its impact on precise orbit determination. *J Geod* 83(12):1145. <https://doi.org/10.1007/s00190-009-0333-2>
- Kehm A, Bloßfeld M, Pavlis E, Seitz F (2018) Future global SLR network evolution and its impact on the terrestrial reference frame. *J Geod* 92:625–635. <https://doi.org/10.1007/s00190-017-1083-1>
- Kelley M (2009) *The Earth's ionosphere. Plasma physics & electrodynamics*. Elsevier, London
- Khan SA, Wahr J, Bevis M, Velicogna I, Kendrick E (2010) Spread of ice mass loss into northwest Greenland observed by GRACE and GPS. *Geophys Res Lett* 37(6):L06501. <https://doi.org/10.1029/2010GL042460>
- Khan SA, Aschwanden A, Björk AA, Wahr J, Kjeldsen KK, Kjaer KH (2015) Greenland Ice Sheet mass balance: a review. *Rep Prog Phys* 78(4):046801. <https://doi.org/10.1088/0034-4885/78/4/046801>
- Khan SA, Sasgen I, Bevis M, van Dam T, Bamber JL, Wahr J, Willis M, Kjaer KH, Wouters B, Helm V et al (2016) Geodetic measurements reveal similarities between post-last glacial maximum and present-day mass loss from the Greenland Ice Sheet. *Sci Adv* 2(9):e1600931. <https://doi.org/10.1126/sciadv.1600931>
- King MA, Altamimi Z, Boehm J, Bos M, Dach R, Elsoegui P, Fund F, Hernández-Pajares M, Lavalée D, Mendes Cerveira PJ, Penna N, Riva REM, Steigenberger P, van Dam T, Vittuari L, Williams S, Willis P (2010) Improved constraints on models of glacial isostatic adjustment: a review of the contribution of ground-based geodetic observations. *Surv Geophys* 31:465–507. <https://doi.org/10.1007/s10712-010-9100-4>
- Kintner P, Ledvina B, de Paula E (2007) GPS and ionospheric scintillations. *Space Weather* 5:S09003. <https://doi.org/10.1029/2006SW000260>
- Kjeldsen KK, Korsgaard NJ, Björk AA, Khan SA, Box JE, Funder S, Larsen NK, Bamber JL, Colgan W, Van Den Broeke M et al. (2015) Spatial and temporal distribution of mass loss from the Greenland Ice Sheet since AD 1900. *Nature* 528(7582):396–400. <https://doi.org/10.1038/nature16183>
- Klopotek G, Hobiger T, Haas R, Otsubo T (2020) Geodetic VLBI for precise orbit determination of Earth satellites: a simulation study. *J Geod* 94(56):1–26. <https://doi.org/10.1007/s00190-020-01381-9>
- Kuang D, Bertiger W, Desai SD, Haines BJ, Yuan D-N (2019) Observed geocenter motion from precise orbit determination of GRACE satellites using GPS tracking and accelerometer data. *J Geod* 93(10):1835–1844. <https://doi.org/10.1007/s00190-019-01283-5>
- Kuipers Munneke P, Ligtenberg S, Noël B, Howat I, Box J, Mosley-Thompson E, McConnell J, Steffen K, Harper J, Das S, van den Broeke MR (2015) Elevation change of the Greenland Ice Sheet due to surface mass balance and firn processes, 1960–2014. *The Cryosphere* 9(6):2009–2025. <https://doi.org/10.5194/tc-9-2009-2015>
- Kwak Y, Bloßfeld M, Schmid R, Angermann D, Gerstl M, Seitz M (2018) Consistent realization of celestial and terrestrial reference frames. *J Geod* 92:1047–1061. <https://doi.org/10.1007/s00190-018-1130-6>
- Lambeck K, Rouby H, Purcell A, Sun Y, Sambridge M (2014) Sea level and global ice volumes from the last glacial maximum to the holocene. *Proc Natl Acad Sci USA* 111(43):15296–15303. <https://doi.org/10.1073/pnas.1411762111>
- Landerer FW, Flechtner FM, Save H, Webb FH, Bandikova T, Bertiger WI, Betadpur SV, Byun SH, Dahle C, Dobslaw H, Fahnestock E, Harvey N, Kang Z, Kruizinga G. LH, Loomis BD, McCullough C, Murböck M, Nagel P, Paik M, Pie N, Poole S, Strelakov D, Tamisiea ME, Wang F, Watkins MM, Wen H-Y, Wiese DN, Yuan D-N (2020) Extending the global mass change data record: GRACE Follow-On instrument and science data performance. *Geophys Res Lett* 47(12):e2020GL088306. <https://doi.org/10.1029/2020GL088306>
- Lisdat C, Grosche G, Quintin N, Shi C, Raupach SMF, Grebing C, Nicolodi D, Stefani F, Al-Masoudi A, Dörscher S, Häfner S, Robyr J-L, Chiodo N, Bilicki S, Bookjans E, Koczwara A, Koke S, Kuhl A, Wiotte F, Meynadier F, Camisard E, Abgrall M, Lours M, Legero T, Schnatz H, Sterr U, Denker H, Chardonnet C, Coq YL, Santarelli G, Amy-Klein A, Targat RL, Lodewyck J, Lopez O, Pottier P-E (2016) A clock network for geodesy and fundamental science. *Nat Commun* 7:12443. <https://doi.org/10.1038/ncomms12443>
- Loeb NG, Doelling DR (2020) CERES Energy Balanced and Filled (EBAF) from afternoon-only satellite orbits. *Remote Sens* 12(8):1280. <https://doi.org/10.3390/rs12081280>
- Loeb NG, Doelling DR, Wang H, Su W, Nguyen C, Corbett JG, Liang L, Mitrescu C, Rose FG, Kato S (2018) Clouds and the Earth's Radiant Energy System (CERES) Energy Balanced and Filled (EBAF) Top-of-Atmosphere (TOA) Edition-4.0 Data Product. *J Clim* 31(2):895–918. <https://doi.org/10.1175/JCLI-D-17-0208.1>
- Loomis BD, Rachlin KE, Luthcke SB (2019) Improved Earth oblateness rate reveals increased ice sheet losses and mass-driven sea level rise. *Geophys Res Lett* 46(12):6910–6917. <https://doi.org/10.1029/2019GL082929>
- Loomis BD, Rachlin KE, Wiese DN, Landerer FW, Luthcke SB (2020) Replacing GRACE/GRACE-FO with Satellite Laser Ranging: Impacts on Antarctic ice sheet mass change. *Geophys Res Lett* 47(3):e2019GL085488. <https://doi.org/10.1029/2019GL085488>
- Luceri V, Pirri M, Rodríguez J, Appleby G, Pavlis EC, Müller H (2019) Systematic errors in SLR data and their impact on the ILRS products. *J Geod* 93(11):2357–2366. <https://doi.org/10.1007/s00190-019-01319-w>
- Luthcke SB, Zelensky NP, Rowlands DD, Lemoine FB, Williams TA (2003) The 1-centimeter orbit: Jason-1 Precision Orbit Determination using GPS, SLR, DORIS, and altimeter data special issue: Jason-1 calibration/validation. *Mar Geodesy* 26(3–4):399–421. <https://doi.org/10.1080/714044529>
- L'Ecuyer TS, Beaudoin HK, Rodell M, Olson W, Lin B, Kato S, Clayton CA, Wood E, Sheffield J, Adler R, Huffman G, Bosilovich M, Gu G, Robertson F, Houser PR, Chambers D, Famiglietti JS, Fetzer E, Liu WT, Gao X, Schlosser CA, Clark E, Lettenmaier DP, Hilburn K (2015) The observed state of the energy budget in the early twenty-first century. *J Clim* 28(21):8319–8346. <https://doi.org/10.1175/JCLI-D-14-00556.1>
- Mader GL (1999) GPS antenna calibration at the National Geodetic Survey. *GPS Solut* 3(1):50–58
- Männel B (2016) Co-Location of Geodetic Observation Techniques in Space. PhD thesis, ETH Zürich
- Männel B, Rothacher M (2017) Geocenter variations derived from a combined processing of LEO- and ground-based GPS observations. *J Geod* 91(8):933–944. <https://doi.org/10.1007/s00190-017-0997-y>
- Mao X, Arnold D, Girardin V, Villiger A, Jäggi A (2021) Dynamic GPS-based LEO orbit determination with 1cm precision using the Bernese GNSS Software. *Adv Space Res* 67(2):788–805. <https://doi.org/10.1016/j.asr.2020.10.012>
- Marti F, Blazquez A, Meyssignac B, Ablain M, Barnoud A, Fraudeau R, Jugier R, Chenal J, Larnicol G, Pfeffer J, Restano M, Benveniste J (2022) Monitoring the ocean heat content change and the Earth energy imbalance

- from space altimetry and space gravimetry. *Earth Syst Sci Data* 14(1):229–249. <https://doi.org/10.5194/essd-14-229-2022>
- Medley B, Neumann TA, Zwally HJ, Smith BE (2020) Forty-year simulations of firn processes over the Greenland and Antarctic ice sheets. *The Cryosphere Discussions* pages 1–35. <https://doi.org/10.5194/tc-2020-266>
- Meindl M, Beutler G, Thaller D, Dach R, Jäggi A (2013) Geocenter coordinates estimated from GNSS data as viewed by perturbation theory. *Adv Space Res* 51(7):1047–1064. <https://doi.org/10.1016/j.asr.2012.10.026>
- Métivier L, Greff-Lefftz M, Altamimi Z (2010) On secular geocenter motion: the impact of climate changes. *Earth Planet Sci Lett* 296(3–4):360–366. <https://doi.org/10.1016/j.epsl.2010.05.021>
- Métivier L, Greff-Lefftz M, Altamimi Z (2011) Erratum to “On secular geocenter motion: the impact of climate changes” [*Earth Planet Sci Lett* 296 (2010) 360–366]. *Earth Planet Sci Lett* 306(1–2):136–136. <https://doi.org/10.1016/j.epsl.2011.03.026>
- Métivier L, Altamimi Z, Rouby H (2020) Past and present ITRF solutions from geophysical perspectives. *Adv Space Res* 65(12):2711–2722. <https://doi.org/10.1016/j.asr.2020.03.031>
- Métivier L, Rouby H, Rebischung P, Altamimi Z (2020) ITRF2014, Earth figure changes, and geocenter velocity: implications for GIA and recent ice melting. *J Geophys Res Solid Earth*, 125(2):e2019JB018333. <https://doi.org/10.1029/2019JB018333>
- Meysignac B, Boyer T, Zhao Z, Hakuba MZ, Landerer FW, Stammer D, Köhl A, Kato S, L’Ecuyer T, Ablain M, Abraham JP, Blazquez A, Cazenave A, Church JA, Cowley R, Cheng L, Domingues CM, Giglio D, Gouretski V, Ishii M, Johnson GC, Killick RE, Legler D, Llovel W, Lyman J, Palmer MD, Piotrowicz S, Purkey SG, Roemmich D, Roca R, Savita A, von Schuckmann K, Speich S, Stephens G, Wang G, Wijffels SE, Zilberman N (2019) Measuring global ocean heat content to estimate the earth energy imbalance. *Front Mar Sci* 6:432. <https://doi.org/10.3389/fmars.2019.00432>
- Millan R, Mouginit J, Rabatel A, Morlighem M (2022) Ice velocity and thickness of the world’s glaciers. *Nat Geosci* 15(2):124–129. <https://doi.org/10.1038/s41561-021-00885-z>
- Montenbruck O, Hackel S, Jäggi A (2018) Precise orbit determination of the Sentinel-3A altimetry satellite using ambiguity-fixed GPS carrier phase observations. *J Geod* 92(7):711–726. <https://doi.org/10.1007/s00190-017-1090-2>
- Montenbruck O, Hackel S, Wermuth M, Zangerl F (2021) Sentinel-6A precise orbit determination using a combined GPS/Galileo receiver. *J Geod* 95(9):109. <https://doi.org/10.1007/s00190-021-01563-z>
- Müller J, Dirks D, Kopeikin SM, Lion G, Panet I, Petit G, Visser P (2018) High performance clocks and gravity field determination. *Space Sci Rev* 214(1):1–31. <https://doi.org/10.1007/s11214-017-0431-z>
- National Academies of Sciences, Engineering, and Medicine (2018) Thriving on our changing planet: a Decadal strategy for earth observation from space. The National Academies Press, Washington, <https://doi.org/10.17226/24938>
- National Academies of Sciences, Engineering, and Medicine (2020) Evolving the geodetic infrastructure to meet new scientific needs. The National Academies Press, Washington. <https://doi.org/10.17226/25579>
- Nerem RS, Beckley BD, Fasullo JT, Hamlington BD, Masters D, Mitchum GT (2018) Climate-change-driven accelerated sea-level rise detected in the altimeter era. *Proc Natl Acad Sci USA*. 115(9):2022–2025. <https://doi.org/10.1073/pnas.1717312115>
- Nothnagel A, Artz T, Behrend D (2017) *J Geod* 91:711–721. <https://doi.org/10.1007/s00190-016-0950-5>
- Pearlman MR, Noll CE, Pavlis EC, Lemoine FG, Combrink L, Degnan JJ, Kirchner G, Schreiber U (2019) *J Geod* 93:2161–2180. <https://doi.org/10.1007/s00190-019-01241-1>
- Peltier WR, Argus D, Drummond R (2015) Space geodesy constrains ice age terminal deglaciation: the global ICE-6G\_C (VM5a) model. *J Geophys Res Solid Earth* 120(1):450–487. <https://doi.org/10.1002/2014JB011176>
- Peter H, Meyer U, Lasser M, Jäggi A (2022) COST-G gravity field models for precise orbit determination of Low Earth Orbiting satellites. *Adv Space Res* 69(12):4155–4168. <https://doi.org/10.1016/j.asr.2022.04.005>
- Petit G, Luzum B (eds) (2010) IERS Conventions (2010). IERS Technical Note No. 36. [https://iers-conventions.obspm.fr/conventions\\_material.php](https://iers-conventions.obspm.fr/conventions_material.php). Accessed 09 Dec 2022
- Plag H-P, Pearlman M (eds) (2009) *Global geodetic observing system*. Springer, Berlin
- Qu Z, Guo J, Zhao Q (2021) Phase center corrections for BDS IGSO and MEO satellites in IGB14 and IGSR3 frame. *Remote Sens* 13(4):745. <https://doi.org/10.3390/rs13040745>
- Raghuraman SP, Paynter D, Ramaswamy V (2021) Anthropogenic forcing and response yield observed positive trend in Earth’s energy imbalance. *Nat Commun* 12(1):4577. <https://doi.org/10.1038/s41467-021-24544-4>
- Rebischung P, Altamimi Z, Springer T (2014) A collinearity diagnosis of the GNSS geocenter determination. *J Geod* 88(1):65–85. <https://doi.org/10.1007/s00190-013-0669-5>
- Richter HMP, Lück C, Klos A, Sideris MG, Rangelova E, Kusche J (2021) Reconstructing GRACE-type time-variable gravity from the Swarm satellites. *Sci Rep* 11(1):1117. <https://doi.org/10.1038/s41598-020-80752-w>
- Riddell AR, King MA, Watson CS, Sun Y, Riva REM, Rietbroek R (2017) Uncertainty in geocenter estimates in the context of ITRF2014. *J Geophys Res Solid Earth* 122(5):4020–4032. <https://doi.org/10.1002/2016JB013698>
- Ries JC, Eanes RJ, Shum CK, Watkins MM (1992) Progress in the determination of the gravitational coefficient of the Earth. *Geophys Res Lett* 19(6):529–531. <https://doi.org/10.1029/92GL00259>
- Rodriguez-Solano CJ, Hugentobler U, Steigenberger P, Bloßfeld M, Fritsche M (2014) Reducing the draconitic errors in GNSS geodetic products. *J Geod* 88(6):559–574. <https://doi.org/10.1007/s00190-014-0704-1>
- Rothacher M, Schaer S, Mervart L, Beutler G (1995) Determination of antenna phase center variations using GPS data. In: *IGS Workshop Proceedings: Special Topics and New Directions*, GeoForschungsZentrum Potsdam, Germany
- Russel C, Luhmann J, Strangeway R (2016) *Space physics, an introduction*. Cambridge University Press, Cambridge
- Scaramuzza S, Dach R, Beutler G, Arnold D, Sušnik A, Jäggi A (2018) Dependency of geodynamic parameters on the GNSS constellation. *J Geod* 92(1):93–104. <https://doi.org/10.1007/s00190-017-1047-5>
- Schmid R, Dach R, Collilieux X, Jäggi A, Schmitz M, Dillsner F (2016) Absolute IGS antenna phase center model igs08.atx: status and potential improvements. *J Geod* 90(4):343–364. <https://doi.org/10.1007/s00190-015-0876-3>
- Schmid R, Rothacher M (2003) Estimation of elevation-dependent satellite antenna phase center variations of GPS satellites. *J Geod* 77(7–8):440–446. <https://doi.org/10.1007/s00190-003-0339-0>
- Schmid R, Rothacher M, Thaller D, Steigenberger P (2005) Absolute phase center corrections of satellite and receiver antennas. *GPS Solut* 9(4):283–293. <https://doi.org/10.1007/s10291-005-0134-x>
- Schmid R, Steigenberger P, Gendt G, Ge M, Rothacher M (2007) Generation of a consistent absolute phase center correction model of GPS receiver and satellite antennas. *J Geod* 81(12):781–798. <https://doi.org/10.1007/s00190-007-0148-y>
- Seitz M, Angermann D, Bloßfeld M, Drewes H, Gerstl M (2012) The 2008 DGF1 realization of the ITRS: DTRF2008. *J Geod* 86(12):1097–1123. <https://doi.org/10.1007/s00190-012-0567-2>
- Seitz M, Steigenberger P, Artz T (2014) Consistent adjustment of combined terrestrial and celestial reference frames. In: Rizos, C., Willis, P. (eds) *Earth on the Edge: Science for a Sustainable Planet*, International Association of Geodesy Symposia, vol 139, Springer, Berlin, Heidelberg. [https://doi.org/10.1007/978-3-642-37222-3\\_28](https://doi.org/10.1007/978-3-642-37222-3_28)
- Seitz M, Bloßfeld M, Angermann D, Seitz F (2022) DTRF2014: DGF1-TUM’s ITRS realization 2014. *Adv Space Res* 69(6):2391–2420. <https://doi.org/10.1016/j.asr.2021.12.037>
- Sert H, Hugentobler U, Karatekin O, Dehant V (2022) Potential of UT1 - UTC transfer to the Galileo constellation using onboard VLBI transmitters. *J Geod* 96:83. <https://doi.org/10.1007/s00190-022-01675-0>
- Shepherd A, Ivins E, Rignot E, Smith B, van den Broeke M, Velicogna I, Whitehouse P, Briggs K, Joughin I, Krinner G, Nowicki S, Payne T, Scambos T, Schlegel N, A G, Agosta C, Ahlstrom A, Babonis G, Barletta VR, Björk AA, Blazquez A, Bonin J, Colgan W, Csatho B, Cullather R, Engdahl ME, Felikson D, Fettweis X, Forsberg R, Hogg AE, Gallee H, Gardner A, Gilbert L, Gourmelen N, Groh A, Gunter B, Hanna E, Harig C, Helm V, Horvath A, Horwath M, Khan S, Kjeldsen KK, Konrad H, Langen PL, Lecavalier B, Loomis B, Luthcke S, McMillan M, Melini D, Mernild S, Mohajerani Y, Moore P, Mottram R, Mouginit J, Moyano G, Muir A, Nagler T, Nield G, Nilsson J, Noël B, Otsuka I, Pattle ME, Peltier WR, Pie N, Rietbroek R, Rott H, Sandberg Sørensen L, Sasgen I, Save H, Scheuchl B, Schrama E, Schröder L, Seo K-W, Simonsen SB, Slater T, Spada G, Sutterley T, Talpe M, Tarasov L, van de Berg WJ, van der Wal W, van Wessel M, Vishwakarma



- BD, Wiese D, Wilton D, Wagner T, Wouters B, Wuite J, The IMBIE Team (2020) Mass balance of the Greenland Ice Sheet from 1992 to 2018. *Nature* 579:233–239. <https://doi.org/10.1038/s41586-019-1855-2>
- Shepherd A, Ivins E, Rignot E, Smith B, van der Broeke M, Velicogna I, Whitehouse PL, Briggs K, Joughin I, Krinner G, Nowicki S, Payne A, Scambos T, Schlegel N, A G, Agosta C, Ahlstrom A, Babonis G, Barletta VR, Blazquez A, Boning J, Csatho B, Cullather R, Felikson D, Fettweis X, Forsberg R, Galée H, Gardner A, Gilbert L, Groh A, Gunther H, Hanna E, Harig C, Helm V, Horwath A, Horwath M, Khan SA, Kjeldsen K, Konrad H, Langen P, Lecavalier, Loomis BD, Luthcke S, McMillan M, Melini D, Mernild SH, Mohajerani Y, Moore P, Mouginit J, Moyano G, Muir A, Nagler T, Niell G, Nilsson J, Noel B, Otsuka, Pattle M, Peltier WR, Pie N, Rietbroek R, Rott H, Sandberg L, Sasgen I, Save H, Scheuchl B, Schrama E, Schroder L, Seo K, Simonsen S, Slater T, Spada G, Sutterley TC, Talpe M, Tarasov L, van de Berg WJ, van der Wal W, van Wessel M, Vishwakarma, Wiese DN, Wouters B, The IMBIE Team (2018) Mass balance of the Antarctic Ice Sheet from 1992 to 2017. *Nature* 558:219–222. <https://doi.org/10.1038/s41586-018-0179-y>
- Sinclair LC, Bergeron H, Swann WC, Khader I, Cossel KC, Cermak M, Newbury NR, Deschênes J-D (2019) Femtosecond optical two-way time-frequency transfer in the presence of motion. *Phys Rev A* 99(2):023844. <https://doi.org/10.1103/PhysRevA.99.023844>
- Soffel M, Klioner SA, Petit G, Wolf P, Kopeikin SM, Bretagnon P, Brumberg VA, Capitaine N, Damour T, Fukushima T, Guinot B, Huang T-Y, Lindgren L, Ma C, Nordtvedt K, Ries JC, Seidelmann PK, Vokrouhlick D, Will CM, Xu C (2003) The IAU 2000 resolutions for astrometry, celestial mechanics, and metrology in the relativistic framework: Explanatory supplement. *Astron J* 126(6):2687–2706. <https://doi.org/10.1086/378162>
- Sørensen LS, Simonsen SB, Forsberg R, Khvorostovsky K, Meister R, Engdahl ME (2018) 25 years of elevation changes of the Greenland Ice Sheet from ERS, Envisat, and CryoSat-2 radar altimetry. *Earth Planet Sci Lett* 495:234–241. <https://doi.org/10.1016/j.epsl.2018.05.015>
- Sošnica K, Jäggi A, Meyer U, Thaller D, Beutler G, Arnold D, Dach R (2015) Time variable Earth's gravity field from SLR satellites. *J Geod* 89(10):945–960. <https://doi.org/10.1007/s00190-015-0825-1>
- Sovers OJ, Fanselow JL, Jacobs CS (1998) Astrometry and geodesy with radio interferometry: experiments, models, results. *Rev Mod Phys* 70:1393–1454. <https://doi.org/10.1103/RevModPhys.70.1393>
- Steigenberger P, Fritsche M, Dach R, Schmid R, Montenbruck O, Uhlemann M, Prange L (2016) Estimation of satellite antenna phase center offsets for Galileo. *J Geod* 90(8):773–785. <https://doi.org/10.1007/s00190-016-0909-6>
- Štěpánek P, Duan B, Filler V, Hugentobler U (2020) Inclusion of GPS clock estimates for satellites Sentinel-3A/3B in DORIS geodetic solutions. *J Geod* 94(12):116. <https://doi.org/10.1007/s00190-020-01428-x>
- Sun Y, Ditmar P, Riva R (2017) Statistically optimal estimation of degree-1 and C20 coefficients based on GRACE data and an ocean bottom pressure model. *Geophys J Int* 210(3):1305–1322. <https://doi.org/10.1093/gji/ggx241>
- Sun Y, Riva R, Ditmar P (2016) Optimizing estimates of annual variations and trends in geocenter motion and J2 from a combination of GRACE data and geophysical models. *J Geophys Res Solid Earth* 121(11):8352–8370. <https://doi.org/10.1002/2016JB013073>
- Swenson S, Chambers D, Wahr J (2008) Estimating geocenter variations from a combination of GRACE and ocean model output. *J Geophys Res Solid Earth* 113:B08410. <https://doi.org/10.1029/2007JB005338>
- Tapley BD, Bettadpur S, Ries JC, Thompson PF, Watkins MM (2004) GRACE measurements of mass variability in the Earth system. *Science* 305:503–505. <https://doi.org/10.1126/science.1099192>
- Thaller D, Dach R, Seitz M, Beutler G, Mareyen M, Richter B (2011) Combination of GNSS and SLR observations using satellite co-locations. *J Geod* 85(5):257–272. <https://doi.org/10.1007/s00190-010-0433-z>
- Thaller D, Sošnica K, Dach R, Jäggi A, Beutler G, Mareyen M, Richter B (2014) Geocenter coordinates from GNSS and combined GNSS-SLR solutions using satellite co-locations. In: Rizos, C., Willis, P. (eds) *Earth on the Edge: Science for a Sustainable Planet*, International Association of Geodesy Symposia, vol 139, Springer, Berlin, Heidelberg. [https://doi.org/10.1007/978-3-642-37222-3\\_16](https://doi.org/10.1007/978-3-642-37222-3_16)
- Trenberth KE (2014) Challenges for observing and modeling the global water cycle. In: Lakshmi V, Alsdorf D, Anderson M, Biancamaria S, Cosh M, Entin J, Huffman G, Kustas W, van Oevelen P, Painter T, Parajka J, Rodell M, Rüdiger C (eds) *Remote Sensing of the Terrestrial Water Cycle*, American Geophysical Union. <https://doi.org/10.1002/9781118872086.ch32>
- UN-GGIM (2021) The SDGs geospatial roadmap. United Nations Committee of Experts on Global Geospatial Information Management. <https://ggim.un.org/documents/SDGs-Geospatial-Roadmap.pdf>
- UN-GGIM (2022) Future Geospatial Information Ecosystem: From SDI to SoS and on to the Geoverse. United Nations Committee of Experts on Global Geospatial Information Management. [https://ggim.un.org/meetings/GGIM-committee/12th-Session/documents/Future\\_Geospatial\\_Information\\_Ecosystem\\_Discussion\\_Paper\\_July2022.pdf](https://ggim.un.org/meetings/GGIM-committee/12th-Session/documents/Future_Geospatial_Information_Ecosystem_Discussion_Paper_July2022.pdf)
- UN SDGs' Website (2022) United nations: Department of economic and social affairs, sustainable development. <https://sdgs.un.org/>. Accessed 14 September 2022
- United Nations General Assembly (2015) 69/266. A global geodetic reference frame for sustainable development. Resolution adopted by the General Assembly on 26 February 2015. A/RES/69/266. <https://www.undocs.org/1603Home/Mobile?FinalSymbol=A%2FRES%2F69%2F266&Language=E&DeviceType=Desktop&LangRequested=FALSE>
- Velicogna I, Mohajerani Y, Landerer F, Mouginit J, Noel B, Rignot E, Sutterley T, van den Broeke M, van Wessel M, Wiese D (2020) Continuity of ice sheet mass loss in Greenland and Antarctica from the GRACE and GRACE Follow-On missions. *Geophys Res Lett* 47(8):e2020GL087291. <https://doi.org/10.1029/2020GL087291>
- Velicogna I, Wahr J (2013) Time-variable gravity observations of ice sheet mass balance: precision and limitations of the GRACE satellite data. *Geophys Res Lett* 40(12):3055–3063. <https://doi.org/10.1002/grl.50527>
- Velicogna I, Sutterley TC, Van Den Broeke MR (2014) Regional acceleration in ice mass loss from Greenland and Antarctica using GRACE time-variable gravity data. *Geophys Res Lett* 41(22):8130–8137. <https://doi.org/10.1002/2014GL061052>
- Veng T, Andersen OB (2021) Consolidating sea level acceleration estimates from satellite altimetry. *Adv Space Res* 68(2):496–503. <https://doi.org/10.1016/j.asr.2020.01.016>
- Villiger A, Dach R, Schaer S, Prange L, Jäggi A (2018) Antenna calibrations for TRF scale determination and their influence on coordinate estimation. In: Report on the Symposium of the IAG Subcommission for Europe (EUREF) held in Amsterdam, The Netherlands, 30 May–01 June 2018
- Villiger A, Dach R, Schaer S, Prange L, Zimmermann F, Kuhlmann H, Wübbena G, Schmitz M, Beutler G, Jäggi A (2020) GNSS scale determination using calibrated receiver and Galileo satellite antenna patterns. *J Geod* 94(9):93. <https://doi.org/10.1007/s00190-020-01417-0>
- von Schuckmann K, Cheng L, Palmer MD, Hansen J, Tassone C, Aich V, Adusumilli S, Beltrami H, Boyer T, Cuesta-Valero FJ, Desbryères D, Domingues C, García-García A, Gentine P, Gibson J, Gorfer M, Haimberger L, Ishii M, Johnson GC, Killick R, King BA, Kirchengast G, Kolodziejczyk N, Lyman J, Marzeion B, Mayer M, Monier M, Monselesan DP, Purkey S, Roemmich D, Schweiger A, Seneviratne SI, Shepherd A, Slater DA, Steiner AK, Straneo F, Timmermans M-L, Wijffels SE (2020) Heat stored in the Earth system: where does the energy go? *Earth Syst Sci Data* 12(3):2013–2041. <https://doi.org/10.5194/essd-12-2013-2020>
- Wautelet G, Loyer S, Mercier F, Perosanz F (2017) Computation of GPS P1–P2 differential code biases with JASON-2. *GPS Solut* 21:1619–1631. <https://doi.org/10.1007/s10291-017-0638-1>
- Whitehouse PL, Gomez N, King MA, Wiens DA (2019) Solid Earth change and the evolution of the Antarctic ice sheet. *Nat Commun* 10(1):1–14. <https://doi.org/10.1038/s41467-018-08068-y>
- Whitehouse P, Milne G, Lambeck K (2021) Glacial Isostatic Adjustment. In: Fowler, A., Ng, F. (eds) *Glaciers and Ice Sheets in the Climate System*, Springer Textbooks in Earth Sciences, Geography and Environment, Springer, Cham. [https://doi.org/10.1007/978-3-030-42584-5\\_15](https://doi.org/10.1007/978-3-030-42584-5_15)
- Wouters B, Gardner AS, Moholdt G (2019) Global glacier mass loss during the GRACE satellite mission (2002–2016). *Front Earth Sci* 7:96. <https://doi.org/10.3389/feart.2019.00096>
- Wu X, Collilieux X, Altamimi Z, Vermeersen B, Gross R, Fukumori I (2011) Accuracy of the International Terrestrial Reference Frame origin and Earth expansion. *Geophys Res Lett* 38(13):L13304. <https://doi.org/10.1029/2011GL047450>
- Wu X, Ray J, van Dam T (2012) Geocenter motion and its geodetic and geophysical implications. *J Geodyn* 58:44–61. <https://doi.org/10.1016/j.jog.2012.01.007>

- Wu X, Abbondanza C, Altamimi Z, Chin TM, Collilieux X, Gross RS, Heflin MB, Jiang Y, Parker JW (2015) KALREF-A Kalman filter and time series approach to the International Terrestrial Reference Frame realization. *J Geophys Res Solid Earth* 120(5):3775–3802. <https://doi.org/10.1002/2014JB011622>
- Wübbena G, Schmitz M, Menge F, Böder V, Seeber G (2000) Automated absolute field calibration of gps antennas in real-time. In: Proceedings of the 13th International Technical Meeting of the Satellite Division of The Institute of Navigation (ION GPS 2000), Salt Lake City, UT, September 2000
- Wöppelmann G, Marcos M (2016) Vertical land motion as a key to understanding sea level change and variability. *Rev Geophys* 54(1):64–92. <https://doi.org/10.1002/2015RG000502>
- Xu D, Delva P, Lopez O, Amy-Klein A, Pottie P-E (2019) Reciprocity of propagation in optical fiber links demonstrated to  $10^{-21}$ . *Optics Express* 27(25):36965–36975. <https://doi.org/10.1364/OE.27.036965>
- Zajdel R, Sośnica K, Bury G, Dach R, Prange L (2020) System-specific systematic errors in Earth rotation parameters derived from GPS, GLONASS, and Galileo. *GPS Solut* 24(3):1–15. <https://doi.org/10.1007/s10291-020-00989-w>
- Zajdel R, Sośnica K, Bury G, Dach R, Prange L, Kazmierski K (2021) Sub-daily polar motion from GPS, GLONASS, and Galileo. *J Geod* 95(1):1–27. <https://doi.org/10.1007/s00190-020-01453-w>
- Zajdel R, Sośnica K, Bury G (2021) Geocenter coordinates derived from multi-GNSS: a look into the role of solar radiation pressure modeling. *GPS Solut* 25(1):1. <https://doi.org/10.1007/s10291-020-01037-3>
- Zajdel R, Steigenberger P, Montenbruck O (2022) On the potential contribution of BeiDou-3 to the realization of the terrestrial reference frame scale. *GPS Solut* 26(4):109. <https://doi.org/10.1007/s10291-022-01298-0>
- Zhu YS, Massmann F-H, Yu Y, Reigber C (2003) Satellite antenna phase center offsets and scale errors in GPS solutions. *J Geod* 76(11):668–672. <https://doi.org/10.1007/s00190-002-0294-1>

### Publisher's Note

Springer Nature remains neutral with regard to jurisdictional claims in published maps and institutional affiliations.

Submit your manuscript to a SpringerOpen<sup>®</sup> journal and benefit from:

- Convenient online submission
- Rigorous peer review
- Open access: articles freely available online
- High visibility within the field
- Retaining the copyright to your article

---

Submit your next manuscript at ► [springeropen.com](https://www.springeropen.com)

---